



Dell P513w Series User's Guide

August 2010

www.dell.com | support.dell.com

Machine type(s):

4443

Model(s):

7dw, 3dw

Contents

Safety information.....	5
About your printer.....	6
Thank you for choosing this printer!.....	6
Minimizing your printer's environmental impact.....	6
Finding information about the printer.....	7
Understanding the parts of the printer.....	9
Ordering and replacing supplies.....	11
Ordering ink cartridges.....	11
Replacing ink cartridges.....	11
Recycling Dell products.....	13
Using the printer control panel buttons and menus.....	14
Using the printer control panel.....	14
Changing temporary settings into new default settings.....	16
Changing the Power Saver timeout.....	17
Saving paper and energy with Eco-Mode.....	17
Resetting to factory settings.....	17
Using the printer software.....	19
Minimum system requirements.....	19
Using the Windows printer software.....	19
Using the Macintosh printer software.....	21
Finding and installing optional software.....	22
Updating the printer software (Windows only).....	23
Reinstalling the printer software.....	23
Loading paper and original documents.....	25
Loading paper.....	25
Saving paper default settings.....	28
Loading original documents on the scanner glass.....	29
Printing.....	30
Tips for printing.....	30

Printing basic documents.....	30
Printing specialty documents.....	34
Working with photos.....	36
Printing on both sides of the paper (duplexing).....	42
Managing print jobs.....	45
Copying.....	49
Tips for copying.....	49
Making copies.....	49
Copying photos.....	49
Copying a two-sided document.....	50
Enlarging or reducing images.....	50
Adjusting copy quality.....	51
Making a copy lighter or darker.....	51
Collating copies using the printer control panel.....	51
Repeating an image on one page.....	52
Copying multiple pages on one sheet	52
Making a duplex copy.....	52
Canceling copy jobs.....	53
Scanning.....	54
Tips for scanning.....	54
Scanning to a local or network computer.....	54
Scanning to a flash drive or memory card.....	55
Scanning photos into an editing application.....	55
Scanning documents into an editing application.....	56
Scanning directly to e-mail using the printer software.....	57
Scanning to a PDF.....	58
Scanning FAQ.....	59
Canceling scan jobs.....	59
Networking.....	60
Installing the printer on a wireless network.....	60
Advanced wireless setup.....	65
Networking FAQ.....	71

Maintaining the printer	83
Maintaining ink cartridges.....	83
Cleaning the exterior of the printer.....	85
Cleaning the scanner glass.....	85
Troubleshooting	86
Before you troubleshoot.....	86
Using the Service Center to solve printer problems.....	86
If Troubleshooting does not solve your problem.....	86
Setup troubleshooting.....	86
Jams and misfeeds troubleshooting.....	93
Print troubleshooting.....	95
Copy and scan troubleshooting.....	97
Memory card troubleshooting.....	99
Wireless troubleshooting.....	101
Notices	119
Product information.....	119
Edition notice.....	119
Power consumption.....	121
Index	130

Safety information

Connect the power cord to an electrical outlet that is near the product and easily accessible.

Do not place or use this product near water or wet locations.

Use only the power supply and power cord provided with this product or the manufacturer's authorized replacements.

This product is designed, tested, and approved to meet strict global safety standards with the use of specific manufacturer's components. The safety features of some parts may not always be obvious. The manufacturer is not responsible for the use of other replacement parts.

 **CAUTION—POTENTIAL INJURY:** The area behind the duplex cover has protruding ribs as part of the paper path. To avoid injury, use caution when accessing this area for clearing a paper jam.

 **CAUTION—POTENTIAL INJURY:** Do not cut, twist, bind, crush, or place heavy objects on the power cord. Do not subject the power cord to abrasion or stress. Do not pinch the power cord between objects such as furniture and walls. If any of these things happen, a risk of fire or electrical shock results. Inspect the power cord regularly for signs of such problems. Remove the power cord from the electrical outlet before inspecting it.

Refer service or repairs, other than those described in the user documentation, to a professional service person.

 **CAUTION—SHOCK HAZARD:** To avoid the risk of electric shock when cleaning the exterior of the printer, unplug the power cord from the wall outlet and disconnect all cables from the printer before proceeding.

 **CAUTION—SHOCK HAZARD:** Do not use the fax feature during a lightning storm. Do not set up this product or make any electrical or cabling connections, such as the fax feature, power cord, or telephone, during a lightning storm.

SAVE THESE INSTRUCTIONS.

About your printer

Thank you for choosing this printer!

We've worked hard to make sure it will meet your needs.

To start using your new printer right away, use the setup materials that came with the printer, and then skim the *User's Guide* to learn how to perform basic tasks. To get the most out of your printer, read the *User's Guide* carefully, and make sure you check the latest updates on our Web site.

We're committed to delivering performance and value with our printers, and we want to make sure you're satisfied. If you do encounter any problems along the way, one of our knowledgeable support representatives will be delighted to help you get back on track fast. And if you find something we could do better, please let us know. After all, you are the reason we do what we do, and your suggestions help us do it better.

Minimizing your printer's environmental impact

We are committed to protecting the environment and are continually improving our printers to reduce their environmental impact. By selecting certain printer settings or tasks, you may be able to reduce your printer's environmental impact even further.

Conserving energy

- **Activate Eco-Mode.** This feature sets the screen brightness to low and sets the printer to change to Power Saver mode after the printer is left idle for 10 minutes.
- **Select the lowest Power Saver timeout.** The Power Saver feature puts the printer in a minimum-power standby mode after the printer has been idle for a set amount of time (the Power Saver timeout).
- **Share your printer.** Wireless/network printers allow you to share a single printer among multiple computers, thus conserving energy and other resources.

Conserving paper

- **Activate Eco-Mode.** On selected printer models, this feature sets the printer to automatically print on both sides of the paper (duplex) for print, copy, and fax jobs.
- **Print more than one page image on one side of the paper.** The "Pages per sheet" feature allows you to print multiple pages on one sheet. You can print up to 8 page images on one side of a sheet of paper.
- **Print on both sides of the paper.** Duplexing lets you print on both sides of the paper manually or automatically (depending on your printer model).
- **Preview print jobs before printing.** Use the preview features found in the Print Preview dialog or the printer display (depending on your printer model).
- **Scan and save.** To avoid printing multiple copies, you can scan documents or photographs and save them to a computer program, application, or flash drive for presentation.
- **Use recycled paper.**

Conserving ink



- **Use Quick Print or Draft Mode.** These modes can be used to print documents using less ink than normal and are ideal for printing documents that are mostly text.
- **Use High Yield cartridges.** Inks in High-Yield cartridges allow you to print more pages with fewer cartridges.
- **Clean the printhead.** Before replacing and recycling your ink cartridges, try using the “Clean Printhead” and “Deep Clean Printhead” features. These features clean the printhead nozzles to improve the quality of your prints.

Recycling

- **Recycle the product packaging.**
- **Recycle your old printer instead of throwing it away.**
- **Recycle paper from discarded print jobs.**
- **Use recycled paper.**

Finding information about the printer

Publications

What are you looking for?	Find it here
<p>Initial setup instructions:</p> <ul style="list-style-type: none"> • Connecting the printer • Installing the printer software 	<p>Setup documentation</p> <p>The setup documentation came with the printer.</p> 
<p>Additional setup and instructions for using the printer:</p> <ul style="list-style-type: none"> • Selecting and storing paper and specialty media • Loading paper • Performing printing, copying, scanning, and faxing tasks, depending on your printer model • Configuring printer settings • Viewing and printing documents and photos • Setting up and using printer software • Setting up and configuring the printer on a network, depending on your printer model • Caring for and maintaining the printer • Troubleshooting and solving problems 	<p><i>User's Guide</i></p> <p>The <i>User's Guide</i> is available on the installation software CD.</p>  <p>For updates, check our Web site at support.dell.com.</p>

What are you looking for?	Find it here
<p>Help using the printer software</p>	<p>Windows Help</p> <p>Open a printer software program or application, and then click Help.</p> <p>Click  to view context-sensitive information.</p> <p>Notes:</p> <ul style="list-style-type: none"> • The Help installs automatically with the printer software. • The printer software is located in the printer Program folder or on the desktop, depending on your operating system.
<p>The latest supplemental information, updates, and online technical support:</p> <ul style="list-style-type: none"> • Troubleshooting hints and tips • Frequently asked questions • Documentation • Driver downloads • Live chat support • E-mail support • Telephone support 	<p>Dell Support Web site—support.dell.com</p> <p>Note: Select your country or region, and then select your product to view the appropriate support site.</p> <p>Support telephone numbers and hours of operation for your country or region can be found on the Support Web site.</p> <p>Have the following information ready when you contact support so that they may serve you faster:</p> <ul style="list-style-type: none"> • Service Tag • Express Service Code <p>Note: The Service Tag and Express Service Code appear on labels located on your printer.</p>
<ul style="list-style-type: none"> • Software and Drivers—Certified drivers for your printer and installers for Dell printer software • Readme files—Last-minute technical changes, or advanced technical reference material for experienced users or technicians 	<p>Installation software CD</p> <p>Note: If you purchased your Dell computer and printer at the same time, then documentation and drivers for your printer are already installed on your computer.</p>
<ul style="list-style-type: none"> • Supplies and accessories for your printer • Replacement cartridges 	<p>Dell Printer Supplies Web site—dell.com/supplies</p> <p>You can purchase printer supplies online, by telephone, or in select retail stores.</p>
<ul style="list-style-type: none"> • Safety information for preparing to operate your printer • Regulatory information • Warranty information 	<p><i>Product Information Guide</i></p> <div data-bbox="1068 1423 1263 1671" data-label="Image"> </div> <p>Note: The <i>Product Information Guide</i> may not be available in your country or region.</p>

Understanding the parts of the printer

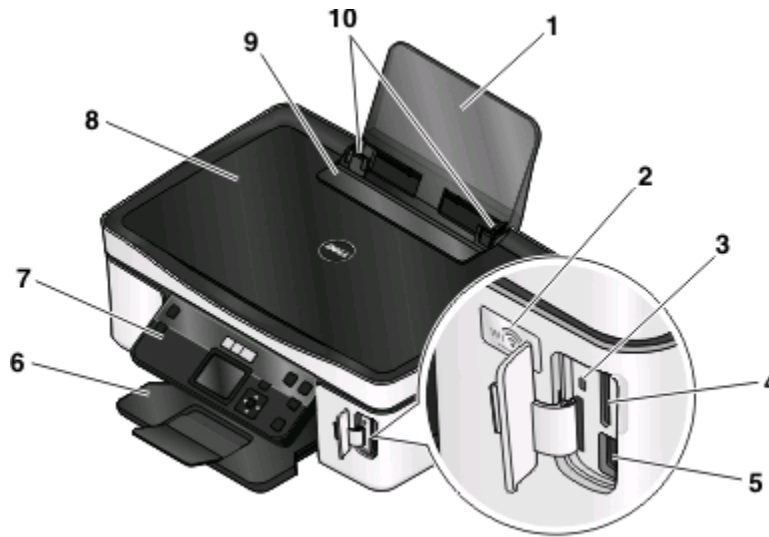

	Use the	To
1	Paper support	Load paper.
2	Wi-Fi indicator	Check wireless status.
3	Card reader light	Check card reader status. The light blinks to indicate that a memory card is being accessed.
4	Memory card slot	Insert a memory card.
5	PictBridge and USB port	Connect a PictBridge-enabled digital camera, a USB Bluetooth adapter, or a flash drive to the printer.
6	Paper exit tray	Hold paper as it exits.
7	Printer control panel	Operate the printer.
8	Scanner lid	Access the scanner glass.
9	Paper feed guard	Prevent items from falling into the paper slot.
10	Paper guides	Keep paper straight when feeding.



	Use the	To
1	Scanner lid	Access the scanner glass.
2	Scanner glass	Scan and copy photos and documents.
3	Security slot	Install an anti-theft cable on your printer.
4	Power supply with port	Connect the printer to a power source.
5	Duplex unit	<ul style="list-style-type: none"> • Print on both sides of a sheet of paper. • Remove paper jams.
6	USB port	Connect the printer to a computer using a USB cable. Warning—Potential Damage: Do not touch the USB port except when plugging in or removing a USB cable or installation cable.
7	Printhead	Install, replace, or remove ink cartridges.
8	Scanner unit	<ul style="list-style-type: none"> • Access the ink cartridges and printhead. • Remove paper jams.

Ordering and replacing supplies

Ordering ink cartridges

Page yields available at www.dell.com/supplies. For best results, use only Dell ink cartridges.

Item	Licensed cartridge ¹	Regular cartridge
Black cartridge	Series 21	Series 21R
Black cartridge, high yield ²	Series 22	Series 22R
Color cartridge	Series 21	Series 21R
Color cartridge, high yield ²	Series 22	Series 22R

¹ Licensed for a single use only. After use, return this cartridge to Dell for remanufacturing, refilling, or recycling. To learn more about recycling Dell products, visit www.dell.com/recycling.

² Available only on the Dell Web site at www.dell.com/supplies.

Replacing ink cartridges

Make sure you have a new ink cartridge or cartridges before you begin.

- 1 Turn on your printer.
- 2 Open the printer.

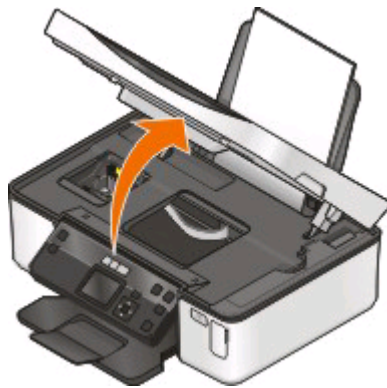

Note: The printhead moves to the cartridge installation position.

3 Press the release tab, and then remove the used ink cartridge or cartridges.

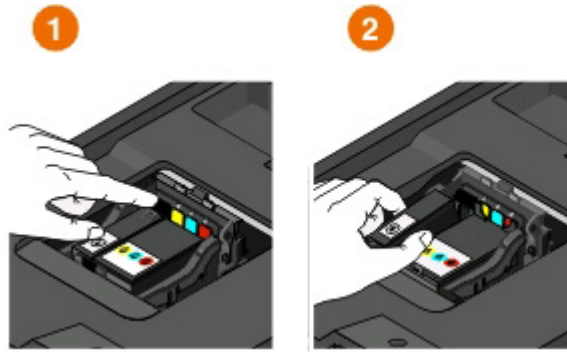

Warning—Potential Damage: Do not remove the old cartridges until you have the new cartridges available, or the ink remaining in the printhead may dry out and clog the nozzles.

4 Unpack the cartridges.

If your ink cartridge comes with a muzzle cap, then remove the cap.

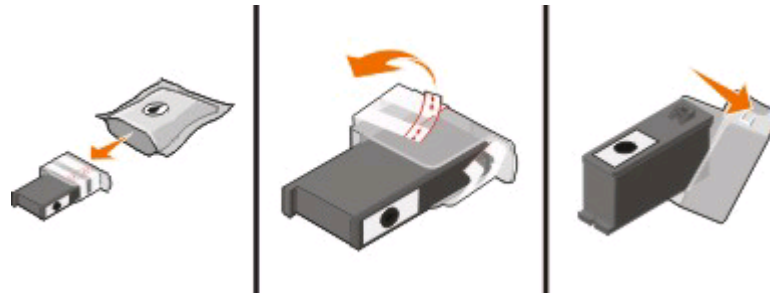

If your ink cartridge comes with a twist cap, then twist and remove the cap.

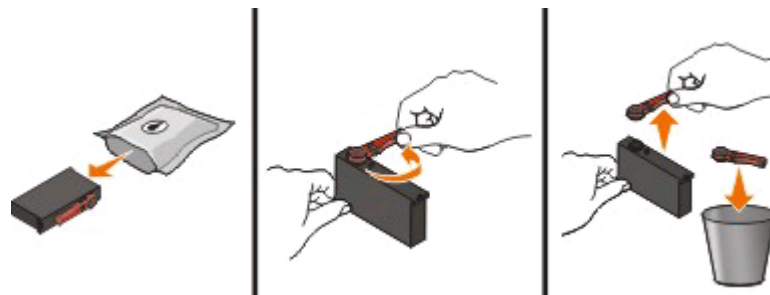

- 5 Install each cartridge. If necessary, use two hands.

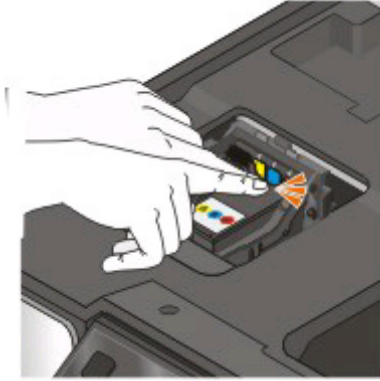



Note: Install the new ink cartridges immediately after removing the protective cap to avoid exposing the ink to air.

- 6 Close the printer.

Recycling Dell products

To return Dell products to Dell for recycling:







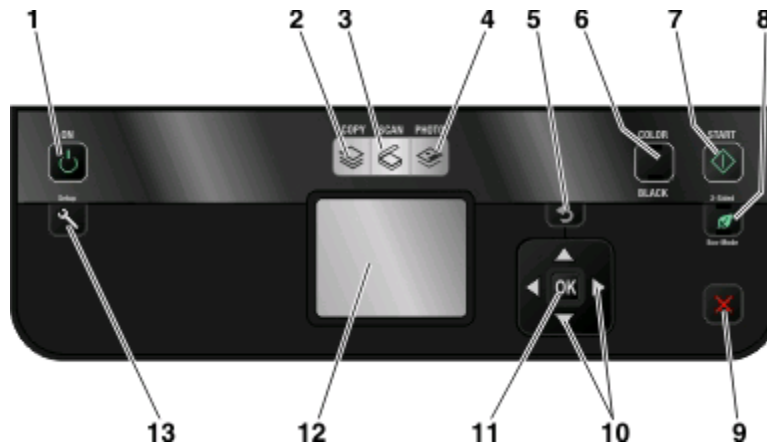

- 1 Click  or **Start**.
- 2 Click **All Programs** or **Programs**, and then select the printer program folder from the list.
- 3 Select **Printer Home**.
- 4 Choose your printer from the printer drop-down list.
- 5 From the Maintenance tab, click **Order supplies**.
- 6 Click .
- 7 Follow the instructions on the computer screen.



Using the printer control panel buttons and menus

Using the printer control panel

The following diagrams explain the sections of the printer control panel:



	Use	To
1	Power 	<ul style="list-style-type: none"> Turn the printer on and off. Switch to Power Saver mode. <p>Note: When the printer is on, press  to switch to Power Saver mode. Press and hold  for three seconds to turn off the printer.</p>
2	Copy 	Access the copy menu and make copies.
3	Scan 	Access the scan menu and scan documents.
4	Photo 	Access the photo menu and print photos.
5	Back 	<ul style="list-style-type: none"> Return to the previous screen. Exit from one menu level to a higher one.
6	Color/Black	Switch to color mode or black-and-white mode.
7	Start 	Start a print, scan, or copy job, depending on which mode is selected.





	Use	To
8	2-Sided/Eco-Mode	<p>Activate 2-Sided to:</p> <ul style="list-style-type: none"> • Print on both sides of the paper (duplex). <p>Activate Eco-Mode to:</p> <ul style="list-style-type: none"> • Print on both sides of the paper (duplex). • Change to Power Saver mode after the printer is left idle for 10 minutes. • Set screen brightness to low.
9	Cancel 	<ul style="list-style-type: none"> • Cancel a print, copy, or scan job in progress. • Exit from a menu level of the Copy, Scan, Photo, or File Print menu to the top level of a menu. • Exit from a menu level of the Setup menu to the top level of the previous mode. • Clear current settings or error messages, and return to default settings.
10	Arrow buttons	<ul style="list-style-type: none"> • Choose a menu or submenu item that appears on the display.
11	Select 	<ul style="list-style-type: none"> • Select menu options. • Save settings. • Feed or eject paper. Press and hold for 3 seconds to feed or eject paper from the printer.
12	Display Note: The display is turned off in Power Saver mode.	View: <ul style="list-style-type: none"> • Printer status • Messages • Menus
13	Setup 	Access the setup menu and change printer settings. Note: The Copy, Scan, and Photo button lights are off when this button is selected.

Changing temporary settings into new default settings

The following menus revert to default settings after two minutes of inactivity or after the printer is turned off:

Copy menu	<ul style="list-style-type: none">• Copies• Quality• Resize• Lighter/Darker• Collate• Photo Reprint• Pages per Sheet• Original Size• Copies per Sheet• Content Type
Scan menu	<ul style="list-style-type: none">• Quality• Original Size
Fax menu (selected models only)	<ul style="list-style-type: none">• Lighter/Darker• Quality
Photo menu	<p>The following Photo options will not time out after two minutes of inactivity or after you turn off the printer, but they will return to the factory default settings when a memory card or flash drive is removed.</p> <ul style="list-style-type: none">• Layout• Colorized Effect• Photo Size• Quality

To change the temporary settings into new default settings

- 1 From the printer control panel, press .
- 2 Press the up or down arrow button to scroll to **Defaults**, and then press .
- 3 Press the up or down arrow button to scroll to **Set Defaults**, and then press .
Use Current appears on the display.
- 4 Press  again to select **Use Current**.
- 5 Press  until you exit Setup, or press another mode button.

To disable the settings timeout feature

You can disable the settings timeout feature if you do not want the printer to revert to the default settings after two minutes of inactivity or after the printer is turned off.



- 1 From the printer control panel, press .
- 2 Press the up or down arrow button to scroll to **Device Setup**, and then press .

Using the printer control panel buttons and menus

- 3 Press the up or down arrow button to scroll to **Clear Settings Timeout**, and then press **OK**.
- 4 Press the up or down arrow button to scroll to **Never**, and then press **OK**.
- 5 Press  until you exit Setup, or press another mode button.

Changing the Power Saver timeout

The Power Saver timeout is the time it takes for the printer to switch to Power Saver mode when the printer is left idle. The Power Saver feature optimizes energy efficiency by reducing the printer power consumption (as much as 28 percent on some printer models) compared to the default printer settings. To save the most energy, select the lowest Power Saver timeout.

- 1 From the printer control panel, press .
- 2 Press the up or down arrow button to scroll to **Device Setup**, and then press **OK**.
- 3 Press the up or down arrow button to scroll to **Power Saver**, and then press **OK**.
- 4 Press the up or down arrow button to select a Power Saver timeout, and then press **OK**.
- 5 Press  until you exit Setup, or press another mode button.

Saving paper and energy with Eco-Mode

The Eco-Mode feature significantly cuts paper usage, reduces paper waste, optimizes energy efficiency, and saves money.

Note: If you are using Eco-Mode, then the Eco-Mode settings override any changes you may make to individual settings that are part of Eco-Mode.

When Eco-Mode is enabled, the printer automatically switches to the following settings:

- The printer display is dimmed.
- The printer changes to Power Saver mode after ten minutes.
- The printer prints on both sides of the paper (duplex) for print, copy, and fax jobs.

To enable Eco-Mode, press the **2-Sided/Eco-Mode** button until the light near "Eco-Mode" comes on.

Resetting to factory settings







Resetting to factory default settings will delete all the printer settings you have previously selected.

Using the printer control panel menus

- 1 From the printer control panel, press .
- 2 Press the up or down arrow button to scroll to **Defaults**, and then press **OK**.
- 3 Press the up or down arrow button to scroll to **Set Defaults**, and then press **OK**.

- 4 Press the up or down arrow button to scroll to **Use Factory**, and then press **OK**.
- 5 When prompted to set the initial settings of your printer, make your selections using the printer control panel buttons.
Initial Setup Complete appears on the display.

Using a button combination (if you cannot read the current language)

- 1 Turn off the printer.
Note: If you have set the Power Saver timeout in the Setup menu, then press and hold  for three seconds to turn off the printer.
- 2 From the printer control panel, press and hold  and  and then press and release  to turn the printer on.
Note: Do not release  and  until **Language Selection** appears on the display, indicating that the printer has been reset.
- 3 When prompted to set the initial settings of your printer, make your selections using the printer control panel buttons.
Initial Setup Complete appears on the display.

Using the printer software

Minimum system requirements

The printer software requires up to 500MB of free disk space.

Supported operating systems

- Microsoft Windows 7
- Microsoft Windows Vista (SP1)
- Microsoft Windows XP (SP3)
- Microsoft Windows 2000 (SP4 or greater)
- Macintosh Intel OS X version 10.6.0 or later (Web only)*
- Macintosh Intel OS X version 10.5.0 or later (Web only)*
- Macintosh Intel OS X version 10.4.4 or later (Web only)*
- Macintosh PowerPC OS X version 10.5.0 or later (Web only)*
- Macintosh PowerPC OS X version 10.4.0 to version 10.4.3 (Web only)*
- Linux Ubuntu 8.04 LTS and 8.10 (Web only)*
- Linux openSUSE 11.0 and 11.1 (Web only)*
- Linux Fedora 10 (Web only)*

* The printer driver for this operating system is available only at support.dell.com.

Note: Updated printer firmware may be available at support.dell.com.

Using the Windows printer software

Software installed during printer installation

When you set up the printer using the installation software CD, all the necessary software was installed. You may have chosen to install some additional programs. The following table provides an overview of various software programs and what they can help you do.

If you did not install these additional programs during initial installation, then reinsert the installation software CD, run the installation software, and then select **Install Additional Software** from the Software Already Installed screen.

Printer software

Use the	To
Dell Printer Home (referred to as Printer Home)	<ul style="list-style-type: none"> • Launch applications or programs. • Access the Fax Solutions software. • Scan or e-mail a photo or document. • Edit scanned documents. • Scan documents to PDF. • Adjust settings for the printer. • Order supplies. • Maintain ink cartridges. • Print a test page. • Register the printer. • Contact technical support.
Dell Fast Pics (referred to as Fast Pics)	Manage, edit, transfer, and print photos and documents.
Adobe™ Photo Album Starter Edition	View, manage, and edit photos.
Dell Toolbar (referred to as Toolbar)	Print, scan, or convert local files from Windows.
Dell Ink Management System	Order ink.
Dell Fax Solutions (referred to as Fax Solutions)	<ul style="list-style-type: none"> • Send a fax. • Receive a fax in three-in-one printers. • Add, edit, or delete contacts in the built-in phone book. • Access the Dell Fax Setup Utility. Use the Fax Setup Utility to set the Speed Dial and Group Dial numbers, set Ringing and Answering, and print fax history and status reports.
Abby Sprint OCR	Scan a document and produce text that you can edit with a word-processing program.
Dell Wireless Setup Utility (referred to as Wireless Setup Utility)	<ul style="list-style-type: none"> • Set up the wireless printer on a wireless network. • Change the wireless settings of the printer. <p>Note: This program is installed automatically with the printer software if the printer has wireless capability.</p>
Dell Service Center (referred to as Service Center)	<ul style="list-style-type: none"> • Troubleshoot the printer. • Access the printer maintenance functions. • Contact technical support. <p>Notes:</p> <ul style="list-style-type: none"> • This program is installed automatically with the printer software. • You may be prompted to install this program from the Web, depending on your printer model.

Use the	To
Printing Preferences	<p>When you select File → Print with a document open and then click Properties, a Printing Preferences dialog appears. The dialog lets you select options for the print job, such as the following:</p> <ul style="list-style-type: none"> • Select the number of copies to print. • Print two-sided copies. • Select the paper type. • Add a watermark. • Enhance images. • Save settings. <p>Note: Printing Preferences is installed automatically with the printer software.</p>

Note: Your printer may not come with some of these programs or some of the functions of these programs, depending on the features of the printer that you purchased.

Using the Macintosh printer software

Software installed during printer installation

Software resident in the Macintosh OS

Use the	To
Print dialog	Adjust the print settings and schedule print jobs.
Printer Services dialog (not available in Mac OS X version 10.5 or later)	<ul style="list-style-type: none"> • Access the printer utility. • Troubleshoot. • Order ink or supplies. • Contact Dell. • Check the printer software version installed on the computer.

Printer software

Applications are installed along with the printer software during installation. These applications are saved in the printer folder that appears on the Finder desktop after installation.

- 1 From the Finder desktop, double-click the printer folder.
- 2 Double-click the icon of the application that you want to use.

Use the	To
Dell All-In-One Center (referred to as All-In-One Center)	<ul style="list-style-type: none"> • Scan photos and documents. • Customize settings for scan jobs.
Dell AIO Setup Utility (referred to as AIO Setup Utility)	<ul style="list-style-type: none"> • Customize settings for fax jobs. • Create and edit the Contacts list.

Use the	To
Dell Network Card Reader (referred to as Network Card Reader)	<ul style="list-style-type: none"> • View the contents of a memory device inserted into a network printer. • Transfer photos and PDF documents from a memory device to the computer over a network.
Dell Printer Utility (referred to as Printer Utility)	<ul style="list-style-type: none"> • Get help with cartridge installation. • Print a test page. • Print an alignment page. • Clean the printhead nozzles. • Order ink or supplies. • Register the printer. • Contact technical support.
Dell Wireless Setup Assistant (referred to as Wireless Setup Assistant)	Set up the printer on a wireless network.

Note: Your printer may not come with these applications, depending on the features of the printer that you purchased.

Finding and installing optional software

For Windows users

- 1 Click  or **Start**.
- 2 Click **All Programs** or **Programs**, and then select the printer program folder from the list.
- 3 Navigate to:
Printer Home > select your printer > **Support** tab > **On-line support**
- 4 From the Web site, select your printer and then download the driver.
- 5 Install additional or optional software.

For Macintosh users

- 1 From the Finder desktop, double-click the printer folder.
- 2 Double-click the **Printer Utility** icon.
- 3 From the Web Links tab, click **Customer Support**.
- 4 From the Web site, select your printer and download the driver.
- 5 Install additional or optional software.

Updating the printer software (Windows only)

Checking for software updates

- 1 Click  or **Start**.
- 2 Click **All Programs** or **Programs**, and then select the printer program folder from the list.
- 3 Select **Printer Home**.
- 4 Choose your printer from the printer drop-down list.
- 5 From the Support tab, select **Check for updates**.
- 6 Follow the instructions on the computer screen.

Enabling automatic software updates

- 1 With a document open, click **File → Print**.
- 2 Click **Properties, Preferences, Options, or Setup**.
- 3 From the Advanced tab, click **More Options**.
- 4 In the Software Updates section, select **Allow automatic updates from the web for my software**.
- 5 Click **OK**.

Reinstalling the printer software

When you set up the printer using the installation software CD, all the necessary software was installed. If you encountered problems while installing, or if your printer does not appear in the Printers folder or as a printer option when you send a print job, then try removing and reinstalling the printer software.

Uninstalling the printer software

For Windows users

- 1 Click  or **Start**.
- 2 Click **All Programs** or **Programs**, and then select the printer program folder from the list.
- 3 Select the uninstall option.
- 4 Follow the instructions on the computer screen to remove the software.
- 5 Once the uninstall process is complete, restart your computer.

For Macintosh users

- 1 From the Finder desktop, double-click the printer folder.
- 2 Double-click the **Uninstaller** icon.
- 3 Follow the instructions on the computer screen.

Installing the printer software

Note: If you installed the printer software on this computer before but need to reinstall the software, then uninstall the current software first.

For Windows users

- 1** Close all open software programs.
- 2** Insert the installation software CD.
If the Welcome screen does not appear after a minute, then launch the CD manually:
 - a** Click , or click **Start** and then click **Run**.
 - b** In the Start Search or Run box, type **D:\setup.exe**, where **D** is the letter of your CD or DVD drive.
 - c** Press **Enter**, or click **OK**.
- 3** Follow the instructions on the Welcome screen.

For Macintosh users

- 1** Close all open applications.
- 2** Download the latest installer from the printer Web site.
- 3** Launch the printer installation software, and then follow the instructions on the computer screen.

Using the Internet

Updated printer software may be available at support.dell.com.

Loading paper and original documents

Loading paper

- 1 Flex the sheets back and forth to loosen them.

Do not fold or crease the paper. Straighten the edges of the stack on a level surface.

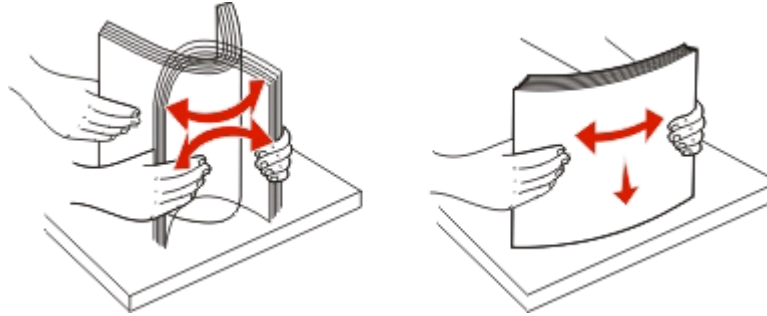



- 2 Center the paper on the paper support.
- 3 Adjust the paper guides so they rest against the edges of the paper.





Note: Do not force paper into the printer. The paper should be flat against the paper support, and the edges should be flush against both paper guides.

- 4 From the printer control panel, select or confirm your paper settings.

Paper and specialty media guidelines

Load up to:	Make sure that:
<p>100 sheets of plain paper</p> 	<ul style="list-style-type: none"> • The paper guides rest against the edges of the paper. • You load letterhead paper with the print side faceup and the top of the letterhead going into the printer first.
<p>25 sheets of heavyweight matte paper</p>	<ul style="list-style-type: none"> • The print side of the paper is faceup. • The paper guides rest against the edges of the paper. • You select Automatic, Normal, or Photo print quality. <p>Note: Draft mode is available but is not recommended for use with expensive paper such as heavyweight matte, labels, photo cards and glossy paper.</p>
<p>20 sheets of banner paper</p> 	<ul style="list-style-type: none"> • You remove all paper from the paper support before inserting banner paper. • You use banner paper designed for inkjet printers. • You place a stack of banner paper on or behind the printer, and feed in the first sheet. • The paper guides rest against the edges of the paper. • You select A4 Banner or Letter Banner paper size.











Load up to:	Make sure that:
<p>10 envelopes</p> 	<ul style="list-style-type: none"> The print side of the envelope is faceup. The paper guides rest against the edges of the envelopes. You print the envelopes with Landscape orientation. <p>Note: If you are mailing within Japan, then the envelope can be printed in Portrait orientation with the stamp in the lower right corner or in Landscape orientation with the stamp in the lower left corner. If you are mailing internationally, then print in Landscape orientation with the stamp in the upper left corner.</p>  <ul style="list-style-type: none"> You select the correct envelope size. Select the next biggest size if the exact envelope size is not listed, and set the left and right margins so your envelope is correctly positioned.
<p>25 sheets of labels</p>	<ul style="list-style-type: none"> The print side of the label is faceup. The paper guides rest against the edges of the paper. You select Automatic, Normal, or Photo print quality. <p>Note: Draft mode is available but is not recommended for use with expensive paper such as heavyweight matte, labels, photo cards and glossy paper.</p>
<p>25 greeting cards, index cards, postcards, or photo cards</p> 	<ul style="list-style-type: none"> The print side of the card is faceup. The paper guides rest against the edges of the cards. You select Automatic, Normal, or Photo print quality. <p>Note: Draft mode is available but is not recommended for use with expensive paper such as heavyweight matte, labels, photo cards and glossy paper.</p>
<p>25 sheets of photo/glossy paper</p>	<ul style="list-style-type: none"> The print side of the paper is faceup. The paper guides rest against the edges of the paper. You select Automatic, Normal, or Photo print quality. <p>Note: Draft mode is available but is not recommended for use with expensive paper such as heavyweight matte, labels, photo cards and glossy paper.</p>

Load up to:	Make sure that:
10 iron-on transfers	<ul style="list-style-type: none"> • You follow the loading instructions on the iron-on transfer packaging. • The print side of the transfer is faceup. • The paper guides rest against the edges of the transfer. • You select Automatic, Normal, or Photo print quality.
50 transparencies	<ul style="list-style-type: none"> • The rough side of the transparencies is faceup. • The paper guides rest against the edges of the transparencies.

Saving paper default settings

You can set the default paper size, paper type, and photo print size for the documents and photos that you print.

Note: These default settings apply only to print, copy, and scan jobs that you initiate from the printer.

- 1 From the printer control panel, press .
- 2 Choose the default settings:
 - If you want to set the default paper size:
 - a Press  to select **Paper Setup**.
 - b Press the up or down arrow button to scroll to **Paper Size**, and then press .
 - c Press the up or down arrow button to select the default paper size for the printer, and then press .
 - If you want to set the default paper type:
 - a Press  to select **Paper Setup**.
 - b Press the up or down arrow button to scroll to **Paper Type**, and then press .
 - c Press the up or down arrow button to select the default paper type for the printer, and then press .
 - If you want to set the default photo print size:
 - a Press the up or down arrow button to scroll to **Defaults**, and then press .
 - b Press  to select **Photo Print Size**.
 - c Press the up or down arrow button to select the default photo print size for the printer, and then press .
- 3 Press  until you exit Setup, or press another mode button.

Loading original documents on the scanner glass

- 1 Open the scanner lid and place the document facedown on the scanner glass.
- 2 Close the scanner lid.



Printing

Tips for printing

- Use the appropriate paper for your print job.
- Select a higher print quality for better prints.
- Make sure there is enough ink in the ink cartridges.
- Remove each sheet as it is printed when printing photos or when working with specialty media.
- Select the borderless setting when printing photos.

Printing basic documents

Printing a document

For Windows users

- 1 With a document open, click **File > Print**.
- 2 Click **Properties, Preferences, Options, or Setup**.
- 3 Select the print quality, the number of copies to print, the type of paper to use, and how the pages should print.
- 4 Click **OK** to close any printer software dialogs.
- 5 Click **OK** or **Print**.

For Macintosh users

- 1 With a document open, choose **File > Page Setup**.
- 2 From the Page Setup dialog, set the printer, paper size, and orientation.
- 3 Click **OK**.
- 4 From the menu bar, choose **File > Print**.
- 5 From the Printer pop-up menu, choose your printer.
- 6 From the print options menu, choose the print quality, the number of copies to print, the type of paper to use, and how the pages should print.
- 7 Click **Print**.

Collating printed copies

When printing multiple copies of a document, you can choose to print each copy as a set (collated) or to print the copies as groups of pages (not collated).

Collated



Not collated



Notes:

- The collate option is available only when you are printing multiple copies.
- To prevent smudging when printing photos, remove each photo as it exits the printer, and then let it dry before stacking.

For Windows users

- 1 With a document open, click **File > Print**.
- 2 Click **Properties, Preferences, Options, or Setup**.
- 3 Navigate to:
Print Setup tab > Copies area
- 4 Enter the number of copies that you want to print, and then select **Collate Copies**.
- 5 Click **OK** to close any printer software dialogs.
- 6 Click **OK** or **Print**.

For Macintosh users

- 1 With a document open, choose **File > Page Setup**.
- 2 From the Page Setup dialog, set the printer, paper size, and orientation.
- 3 Click **OK**.
- 4 From the menu bar, choose **File > Print**.
- 5 From the Printer pop-up menu, choose your printer.
- 6 From the Copies area, enter the number of copies that you want to print, and then choose **Collated**.
- 7 Click **Print**.

Printing pages in reverse order

By default, the first page is printed first. If you want to reverse the order in which pages print to make documents ready to read with the first page on top, then do the following:

For Windows users

- 1 With a document open, click **File > Print**.
- 2 Click **Properties, Preferences, Options, or Setup**.

- 3 From the Copies area of the Print Setup tab, select a page order:
 - To print the last page first, select **Print Last Page First**.
 - To print the first page first, clear the **Print Last Page First** check box.

Note: If two-sided printing is enabled, then you cannot print the last page first. To change the print order, you must first disable two-sided printing.
- 4 Click **OK** to close any printer software dialogs.
- 5 Click **OK** or **Print**.

For Macintosh users

- 1 With a document open, choose **File > Print**.
- 2 From the Printer pop-up menu, choose the printer.
- 3 If necessary, click the disclosure triangle.
- 4 From the print options pop-up menu, choose **Paper Handling**.
- 5 From the Paper Handling menu, or from the Page Order pop-up menu, select a page order:
 - To print the last page first, select **Reverse page order** or **Reverse**.
 - To print the first page first, clear the **Reverse page order** or **Reverse** option.
- 6 Click **Print**.

Printing multiple pages on one sheet

For Windows users

- 1 With a document open, click **File > Print**.
- 2 Click **Properties, Preferences, Options, or Setup**.
- 3 Navigate to:

Advanced tab > Layout list > select **Pages per sheet**
- 4 Select the number of page images to print on each page.
- 5 Adjust other settings as needed.
- 6 Click **OK** to close any printer software dialogs.
- 7 Click **OK** or **Print**.

For Macintosh users

- 1 With a document open, choose **File > Page Setup**.
- 2 From the Page Setup dialog, set the printer, paper size, and orientation.
- 3 Click **OK**.
- 4 From the menu bar, choose **File > Print**.
- 5 From the Printer pop-up menu, choose your printer.

- 6 From the print options pop-up menu, choose **Layout**.
- 7 From the Pages per Sheet pop-up menu, choose the number of page images to print on each page.
- 8 Adjust other settings as needed.
- 9 Click **Print**.

Printing documents from a memory card or flash drive (Windows only)

To enable the File Print function:

- The printer must be connected to a computer through a USB cable or through a network.
- The printer and the computer must be on.
- The memory card or flash drive must contain document files that are supported by the printer. For more information, see "Supported memory cards and file types" on page 37.
- The computer must contain applications that support the file types in the memory device.

- 1 Insert a memory card or flash drive.

When the printer detects the memory device, **Memory Card Detected** or **Storage Device Detected** appears on the display.

- 2 If only document files are stored on the memory device, then the printer automatically switches to File Print mode.

If document files and image files are stored on the memory device, then press the up or down arrow button to scroll to **Documents**, and then press **OK**.

- 3 Select and print the document:

If the printer is using a USB connection

- a Press the up or down arrow button to select the file name of the document that you want to print.
- b Press  to start printing the document.

If the printer is using a Wireless connection (selected models only)

- a Press the up or down arrow button to select the file name of the document that you want to print.
- b Press , and then wait for the printer to connect to the network computer or to finish searching the network for available computers.
- c When prompted, press the up or down arrow button to select the name of the network computer, and then press **OK** to start printing the document.

Notes:

- You may be prompted to enter a PIN if the computer requires it. Enter the PIN using the keypad.
- To assign a computer name and a PIN to the computer, see the Help for the printer software associated with your operating system.

Printing specialty documents

Printing envelopes

For Windows users

- 1 With a document open, click **File > Print**.
- 2 Click **Properties, Preferences, Options, or Setup**.
- 3 Navigate to:
Print Setup tab > Paper Type list > select **Plain Paper**
- 4 Navigate to:
Paper Size list > select your envelope size
If no size matches the envelope size, then set a custom size.
- 5 Select an orientation.
- 6 Click **OK** to close any printer software dialogs.
- 7 Click **OK** or **Print**.

For Macintosh users

- 1 With a document open, choose **File > Page Setup**.
- 2 From the "Format for" pop-up menu, choose your printer.
- 3 From the Paper Size pop-up menu, choose your envelope size.
If no size matches the envelope size, then set a custom size.
- 4 Select an orientation, and then click **OK**.
- 5 From the menu bar, choose **File > Print**.
- 6 From the Printer pop-up menu, choose your printer.
- 7 Click **Print**.

Notes:

- Most envelopes use landscape orientation.
- Make sure the same orientation is also selected in the application.

Printing labels

For Windows users

- 1 With a document open, click **File > Print**.
- 2 Click **Properties, Preferences, Options, or Setup**.

- 3 Navigate to:
Print Setup tab > Paper Type list > select your paper type
- 4 Navigate to:
Paper Size list > select your paper size
If no paper size matches the label sheet size, then set a custom size.
- 5 Click **OK** to close any printer software dialogs.
- 6 Click **OK** or **Print**.

For Macintosh users

- 1 With a document open, choose **File > Page Setup**.
- 2 From the "Format for" pop-up menu, choose your printer.
- 3 From the Paper Size pop-up menu, choose your paper size.
If no paper size matches the label sheet size, then set a custom size.
- 4 Select an orientation, and then click **OK**.
- 5 From the menu bar, choose **File > Print**.
- 6 From the Printer pop-up menu, choose your printer.
- 7 From the print options pop-up menu, choose **Print Settings** or **Quality & Media**.
- 8 From the Paper Type pop-up menu, choose **Card Stock**.
- 9 From the Print Quality menu, choose a print quality other than Quick Print or Draft.
- 10 Click **Print**.

Tips on loading label sheets

- Make sure the top of the label sheet feeds into the printer first.
- Make sure the adhesive on the labels does not extend to within 1 mm of the edge of the label sheet.
- Make sure the paper guide or paper guides rest against the edges of the label sheet.
- Use full label sheets. Partial sheets (with areas exposed by missing labels) may cause labels to peel off during printing, resulting in a paper jam.

Printing on custom-size paper

For Windows users

- 1 With a document open, click **File > Print**.
- 2 Click **Properties, Preferences, Options, or Setup**.
- 3 Navigate to:
Print Setup tab > Paper Size list > select **Custom Size**
- 4 Adjust the settings as needed to create a custom size, and then click **OK**.

5 Click **OK** to close any printer software dialogs.

6 Click **OK** or **Print**.

For Macintosh users

1 With a document open, choose **File > Page Setup**.

2 From the "Format for" pop-up menu, choose your printer.

3 From the Paper Size pop-up menu, choose **Manage Custom Sizes**.

4 Adjust the settings as needed to create a custom size, and then click **OK**.

5 From the Paper Size pop-up menu, choose the custom size you created, and then click **OK**.

6 From the menu bar, choose **File > Print**.

7 From the printer pop-up menu, choose your printer.

8 Click **Print**.

Working with photos

Using a memory card or flash drive with the printer

Memory cards and flash drives are storage devices frequently used with cameras and computers. You can remove the memory card from the camera or the flash drive from the computer and insert it directly into the printer.

1 Insert a memory card into the card slot or a flash drive into the USB port.

Inserting a memory card

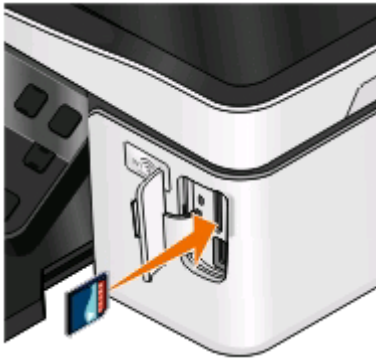

Notes:

- Insert the card with the brand name label facing right.
- Make sure any arrows on the card point toward the printer.
- If necessary, connect the memory card (optional purchase) to the adapter that came with it.
- Make sure that the memory card inserted is supported by the printer. For more information, see "Supported memory cards and file types" on page 37.

Inserting a flash drive

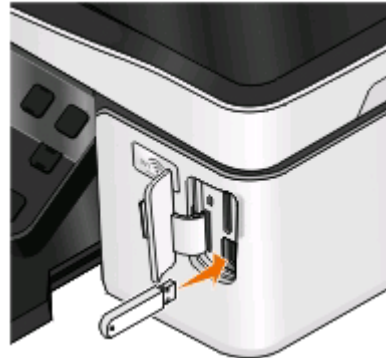

Notes:

- The flash drive uses the same port that is used for a PictBridge camera cable.
- An adapter may be necessary if your flash drive does not fit directly into the port.



Warning—Potential Damage: Do not touch any cables, any network adapter, any connector, the memory device, or the printer in the areas shown while actively printing, reading, or writing from the memory device. A loss of data can occur.

2 Look for **Memory Card Detected** or **Storage Device Detected** on the display.



Notes:

- If the printer does not recognize the memory device, then remove and reinsert it.
- If a flash drive or a digital camera set to mass storage mode is inserted into the USB port while a memory card is in the card slot, then a message appears on the display prompting you to choose which memory device to use.

Supported memory cards and file types

Memory Card	File Type
<ul style="list-style-type: none"> • Secure Digital (SD) • Secure Digital High Capacity (SDHC) • Micro Secure Digital (with adapter) (Micro SD) • Mini Secure Digital (with adapter) (Mini SD) • MultiMedia Card (MMC) • Reduced Size MultiMedia Card (with adapter) (RS-MMC) • MultiMedia Card mobile (with adapter) (MMCmobile) • Memory Stick • Memory Stick PRO • Memory Stick Duo (with adapter) • Memory Stick PRO Duo (with adapter) • xD-Picture Card • xD-Picture Card (Type H) • xD-Picture Card (Type M) 	<p>Documents:</p> <ul style="list-style-type: none"> • .doc (Microsoft Word) • .xls (Microsoft Excel) • .ppt (Microsoft PowerPoint) • .pdf (Adobe Portable Document Format) • .rtf (Rich Text Format) • .docx (Microsoft Word Open Document Format) • .xlsx (Microsoft Excel Open Document Format) • .pptx (Microsoft PowerPoint Open Document Format) • .wpd (WordPerfect) <p>Images:</p> <ul style="list-style-type: none"> • JPEG • TIFF

Printing photos using the printer control panel

- 1** Load photo paper.
- 2** From the printer control panel, press .
- 3** Insert a memory card, flash drive, or digital camera set to mass storage mode.
If document files and image files are stored in the memory device, then press  to select **Photos**.
- 4** Press the up or down arrow button to scroll to **Print Photos**, and then press .

- 5 Press the up or down arrow button to select a photo printing option, and then press **OK**.

Note: You can choose to print all the photos, print photos that fall within a date range, print selected photos by photo range, print photos using pre-defined photo size templates, or print pre-selected photos from a digital camera using Digital Print Order Format (DPOF). The DPOF option appears only when there is a valid DPOF file in your memory device.
- 6 Press the left or right arrow button to select the layout of the photo or photos you want to print, and then press **OK**.
- 7 If you want to adjust the print settings:
 - a Press **OK** again.
 - b Make your selections using the arrow buttons.
 - c After adjusting your settings, press the up or down arrow button to scroll to **Continue**, and then press **OK**.
- 8 Press the **Color/Black** button to set a color or black-and-white print.

When you select color or black-only printing, the light near your choice comes on.
- 9 Press .



Note: For best results, allow the prints to dry at least 24 hours before stacking, displaying, or storing.

Editing photos using the printer control panel

- 1 Load photo paper.
- 2 Insert a memory card or flash drive.

If document files and image files are stored on the memory device, then press **OK** to select **Photos**.
- 3 From the printer control panel, press **OK** to select **Select and Print**.
- 4 Press the left or right arrow button to select the layout of the photo you want to print, and then press **OK**.
- 5 Press the left or right arrow button to select a photo for editing and printing.
- 6 Press the up or down arrow button to scroll to , and then press **OK**.

From here	You can
Brightness	Adjust the brightness of a photo.
Crop	Crop a photo.
Auto Enhance	Enhance a photo automatically.
Reduce Red Eye	Reduce the red-eye effect caused by light reflection.
Rotate	Rotate a photo in 90-degree increments clockwise or counterclockwise.
Colorized Effect	Select whether to print a photo in black and white, sepia, antique brown, or antique gray.
Frames	Select a frame for the photo.

- 7 Press the arrow buttons to make your selections.
- 8 Press the up or down arrow button to scroll to , and then press **OK**.
- 9 Press the up or down arrow button to scroll to , and then press **OK**.

- 10** If you want to adjust the print settings:
- a** Press **OK** again.
 - b** Press the arrow buttons to make your selections.
 - c** Press **OK** to save your selections.
 - d** Press the up or down arrow button to scroll to **Continue**, and then press **OK**.

- 11** Press the **Color/Black** button to set a color or black-and-white print.
When you select color or black-only printing, the light near your choice comes on.

- 12** Press .

Note: For best results, allow the prints to dry at least 24 hours before stacking, displaying, or storing.

Printing photos from a memory device using the printer software

- 1** Load photo paper.
- 2** From the printer control panel, press .
- 3** Insert a memory card or flash drive.
- 4** Transfer or print the photos:

If the printer is using a USB connection

- Fast Pics launches automatically when you insert the memory device. Follow the instructions on the computer screen to transfer the photos to the computer or to print.

If the printer is using a Wireless connection (selected models only)

- a** Press the up or down arrow button to scroll to **Share Media on Network**, and then press **OK**.
- b** Press the up or down arrow button to select the network computer where you want to save the photos, and then press **OK**.
- c** Transfer or print the photos:
 - Fast Pics launches automatically when a connection is established. Follow the instructions on the computer screen to transfer the photos to the computer or to print.

Printing photos from a PictBridge-enabled digital camera

PictBridge is a technology available in most digital cameras that lets you print directly from your digital camera without using a computer.

1 Insert one end of the USB cable into the camera.

Note: Use only the USB cable that came with the camera.

2 Insert the other end of the cable into the PictBridge port on the front of the printer.



Notes:

- Make sure that the digital camera is set to the correct USB mode. If the camera USB selection is incorrect, then the camera is detected as a flash drive, or an error message is displayed on the printer control panel. For more information, see the camera documentation.
- The printer reads only one memory device at a time.



Warning—Potential Damage: Do not touch any cables, any network adapter, any connector, the memory device, or the printer in the areas shown while actively printing, reading, or writing from the memory card. A loss of data can occur.

3 If the PictBridge connection is successful, then the following message appears on the display: **Use Camera to choose and print photos. Press OK to select printer default settings.**

4 If you want to change the default print settings:

a Press **OK** to access the PictBridge menu.

b Press the arrow buttons to select the paper size, paper type, photo size, and layout of the photos that you want to print. Press **OK** each time you make a selection.

Note: The printer will use the default print settings unless you change the print settings from the camera.

5 See the documentation for your camera to begin printing.

Note: If you insert the camera while the printer is performing another job, then wait for the job to finish before printing from the camera.

Printing photos from a memory device using the proof sheet

1 Load letter- or A4-size plain paper.

2 From the printer control panel, press .

3 Insert a memory card or flash drive.

If document files and image files are stored on the memory device, then press **OK** to select **Photos**.

4 Press the up or down arrow button to scroll to **Proof Sheet**, and then press **OK**.

5 Press the up or down arrow button to select an option to print a proof sheet.

You can print a proof sheet:

- For the 20 most recent photos, if there are 20 or more photos on the memory device.
- For all photos on the memory device.
- By date, if the photos on the card were taken on different dates. If you choose this option, then press the arrow buttons to set the start and end dates, and then press **OK** to save your selections.

6 Press .

The proof sheet prints.

7 Follow the instructions on the proof sheet to select which photos to print, the number of copies per photo, red-eye reduction, page layout, print options, and paper size.

Note: When making selections, make sure to fill in the circles completely.

8 When **Scan Proof Sheet** appears on the display, press **OK** and then load the proof sheet facedown on the scanner glass.

Note: If **Scan Proof Sheet** does not appear on the display, then press the up or down arrow button until it appears on the display.

9 Press .

The printer scans the proof sheet.

10 Load photo paper.

Note: Make sure that the paper matches the size that you selected on the proof sheet.

11 Press the **Color/Black** button to set a color or black-and-white print.

When you select color or black-only printing, the light near your choice comes on.

12 Press  to print the photos.

Note: For best results, allow the prints to dry at least 24 hours before stacking, displaying, or storing.

Printing photos from a digital camera using DPOF

If your camera supports Digital Print Order Format (DPOF), then you can specify which photos to print, how many of each, and the print settings while the memory card is still in the camera. The printer recognizes these settings when you insert the memory card into the printer or connect the camera to the printer.

Note: If you specify a photo size while the memory card is still in the camera, then make sure that the size of the paper loaded in the printer is not smaller than the size you specify in the DPOF selection.

1 Load photo paper.

2 From the printer control panel, press .

3 Insert a memory card.

Memory Card Detected appears on the display.

4 Press the up or down arrow button to scroll to **Print Photos**, and then press .

5 Press the up or down arrow button to scroll to **Print Camera Selections (DPOF)**, and then press  to print the photos.

Note: This option appears only if a DPOF file is detected in the memory card.

Note: For best results, allow the prints to dry at least 24 hours before stacking, displaying, or storing.

Printing on both sides of the paper (duplexing)

Printing on both sides of the paper (duplexing) automatically

The automatic duplex unit, available only on select printer models, supports A4- and letter-size paper. If you purchased a model without automatic duplex, or if you need to print duplex using other paper sizes, then see the instructions for printing on both sides of the paper (duplexing) manually.

For Windows users

1 With a document open, click **File > Print**.

2 Click **Properties, Preferences, Options, or Setup**.

3 Navigate to:

Advanced tab > 2-Sided Printing area > select **On**

Note: To use the settings defined in the printer, select **Use Printer Settings**.

4 Select either the **Side Flip** or **Top Flip** option. Side Flip is the setting most often used.

5 Click **OK** to close any printer software dialogs.

6 Click **OK** or **Print**.

To return to single-sided printing, navigate to:

Advanced tab > 2-Sided Printing area > select **Off**

For Macintosh users

1 With a document open, choose **File > Page Setup**.

2 From the Page Setup dialog, set the printer, paper size, and orientation.

3 Click **OK**.

4 From the menu bar, choose **File > Print**.

5 From the Printer pop-up menu, choose your printer.

6 From the print options pop-up menu, choose **Print Settings** or **Quality & Media**.

7 From the Paper Type pop-up menu, choose **Plain Paper**.

8 From the print options pop-up menu, choose **Layout**.

9 From the Two-Sided pop-up menu, choose **Long-Edge binding** or **Short-Edge binding**.

- For Long-Edge binding, pages are bound along the long edge of the page (left edge for portrait, top edge for landscape).

Portrait



Landscape



- For Short-Edge binding, pages are bound along the short edge of the page (top edge for portrait, left edge for landscape).

Portrait



Landscape



10 Click **Print**.

Setting the duplex printing dry time

Using the printer software

For Windows users

- 1 Click , or click **Start** and then click **Run**.
- 2 In the Start Search or Run box, type **control printers**.
- 3 Press **Enter**, or click **OK**.
- 4 Right-click the printer, and then navigate to:
Printing Preferences > Advanced tab > select a dry time setting

Note: Under conditions of high humidity, or if the normal drying time does not allow the ink to dry completely, select **Extended**.

- 5 Click **OK**.

Printing on both sides of the paper (duplexing) manually

For Windows users

- 1 With a document open, click **File > Print**.
- 2 Click **Properties, Preferences, Options, or Setup**.
- 3 Navigate to:
Advanced tab > 2-Sided Printing area > select Manual
Note: The “Print Instruction Page to Assist in Reloading” item is selected automatically.
- 4 Click **OK**. The printer prints the odd-numbered pages and the instruction sheet.
- 5 Flip and reload the paper, following the directions on the instruction sheet to complete the print job.

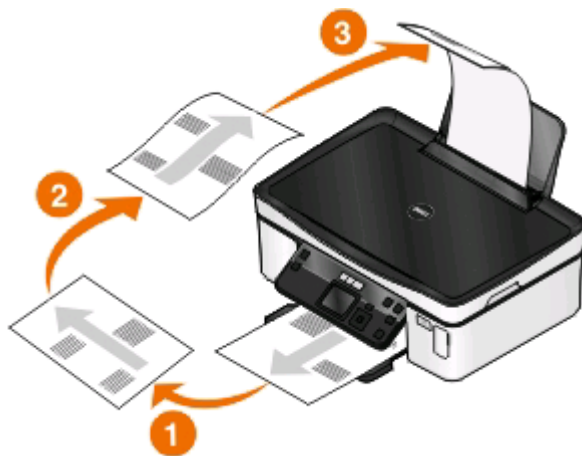

To return to single-sided printing, navigate to:

Advanced tab > 2-Sided Printing area > select Off

For Macintosh users

- 1 With a document open, choose **File > Page Setup**.
- 2 From the Page Setup dialog, set the printer, paper size, and orientation.
- 3 Click **OK**.
- 4 From the menu bar, choose **File > Print**.
- 5 From the Printer pop-up menu, choose your printer.
- 6 From the print options pop-up menu, choose **Paper Handling**.
- 7 From the Print or “Pages to Print” pop-up menu, choose to print the odd-numbered pages.
- 8 Click **Print**.
- 9 Flip and reload the paper.

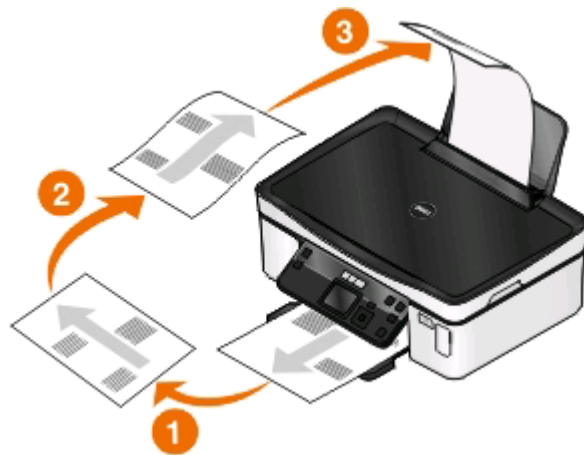

- 10 Repeat steps 4 through 6.
- 11 From the Print or “Pages to Print” pop-up menu, choose to print the even-numbered pages.
- 12 Click **Print**.

Managing print jobs

Setting your printer as the default printer

Your printer should be selected automatically from the Print dialog when you send a print job. If you have to manually select your printer, then it is not the default printer.

To set the default printer:

For Windows users

- 1 Click , or click **Start** and then click **Run**.
- 2 In the Start Search or Run box, type `control printers`.

- 3 Press **Enter**, or click **OK**.
The printer folder opens.
- 4 Right-click the printer, and then select **Set as Default Printer**.

For Macintosh users

- 1 From the Apple menu, choose **System Preferences**.
- 2 Click **Print & Fax**.
- 3 Select the printer from the Default Printer pop-up menu, or select the printer and click **Make Default**, depending on your operating system.

Changing the printing mode

To conserve ink, you can change the default printing mode for all print jobs to Draft or Quick Print. It uses less ink and is ideal for printing text-only documents. If you need to print photos or other high-quality documents, then you can select a different mode from the Print dialog before sending the print job.

To change the default print mode:

For Windows users

- 1 Click , or click **Start** and then click **Run**.
- 2 In the Start Search or Run box, type `control printers`.
- 3 Press **Enter**, or click **OK**.
The printer folder opens.
- 4 Right-click the printer, and then select **Printing Preferences**.
- 5 Select **Quick Print** as the printing mode.

For Macintosh users

- 1 With a document open, choose **File > Print**.
- 2 From the printer pop-up menu, choose the printer.
- 3 From the print options pop-up menu, choose **Print Settings** or **Quality & Media**, depending on your operating system.
- 4 From the Print Quality pop-up menu, choose **Draft** or **Quick Print** as the printing mode.
- 5 From the Presets pop-up menu, choose **Save as**, and then type a name for your setting configuration.
You must choose this configuration name from the Presets pop-up menu for each print job.

Changing the printing mode for a single print job

For Windows users

- 1 With a document open, click **File > Print**.
- 2 Click **Properties**, **Preferences**, **Options**, or **Setup**.

- 3 Select **Automatic**, **Quick Print**, **Normal**, or **Best**.

Note: Printing in Draft or Quick Print mode uses less ink and is ideal for printing text documents.

For Macintosh users

- 1 With a document open, choose **File > Print**.
- 2 From the printer pop-up menu, choose the printer.
- 3 From the print options pop-up menu, choose **Print Settings** or **Quality & Media**, depending on your operating system.
- 4 From the Print Quality pop-up menu, choose **Automatic**, **Draft** or **Quick Print**, **Normal**, **Photo** or **Best**.

Note: Printing using Quick Print uses less ink and is ideal for printing text documents.

Pausing print jobs

For Windows users

- 1 Click , or click **Start** and then click **Run**.
- 2 In the Start Search or Run box, type `control printers`.
- 3 Press **Enter**, or click **OK**.
The printer folder opens.
- 4 Right-click the printer, and then select **Open** or **See what's printing**.
- 5 Pause the print job:
 - If you want to pause a particular print job, then right-click the document name, and then select **Pause**.
 - If you want to pause all print jobs in the queue, then click **Printer**, and then select **Pause Printing**.

For Macintosh users

- 1 Click the printer icon on the Dock.
The print queue dialog appears.
- 2 Pause the print job:
 - If you want to pause a particular print job, then choose the document name, and then click **Hold**.
 - If you want to pause all print jobs in the queue, then click **Pause Printer** or **Stop Jobs**, depending on your operating system.

Resuming print jobs

For Windows users

- 1 Click , or click **Start** and then click **Run**.
- 2 In the Start Search or Run box, type `control printers`.
- 3 Press **Enter**, or click **OK**.
The printer folder opens.

- 4 Right-click the printer, and then select **Open** or **See what's printing**.
- 5 Resume the print job:
 - If you want to resume a particular print job, then right-click the document name, and then select **Resume** or **Restart**.
 - If you want to resume all print jobs in the queue, then click **Printer**, and then clear the selection for Pause Printing.

For Macintosh users

- 1 From the Apple menu, choose **System Preferences**.
- 2 Click **Print & Fax**.
- 3 From the Printers list or pop-up menu, choose the printer.
- 4 Click **Open Print Queue** or **Set Up Printers**, depending on your operating system.
The print queue dialog appears.
- 5 Resume the print job:
 - If you want to resume a particular print job, then choose the document name, and then click **Resume**.
 - If you want to resume all print jobs in the queue, then click **Resume Printer** or **Start Jobs**.

Canceling print jobs

To cancel a print job from the printer control panel, press **X**. To cancel a print job from the computer, do the following:

For Windows users

- 1 Click , or click **Start** and then click **Run**.
- 2 In the Start Search or Run box, type `control printers`.
- 3 Press **Enter**, or click **OK**.
The printer folder opens.
- 4 Right-click the printer, and then select **Open** or **See what's printing**.
- 5 Cancel the print job:
 - If you want to cancel a particular print job, then right-click the document name, and then select **Cancel**.
 - If you want to cancel all print jobs in the queue, then click **Printer** > **Cancel All Documents**.

For Macintosh users

- 1 Click the printer icon on the Dock.
- 2 From the print queue dialog, choose the job you want to cancel, and then click **Delete**.

Copying

Automatic Document Feeder (ADF)	Scanner glass
<p>Use the ADF for multiple-page documents.</p> <p>Note: The ADF is available only on selected models. If you purchased a printer without an ADF, then load original documents or photos on the scanner glass.</p>	 <p>Use the scanner glass for single pages, small items (such as postcards or photos), transparencies, photo paper, or thin media (such as magazine clippings).</p>

Tips for copying

- When using the ADF, adjust the paper guide on the ADF to the width of the original document.
- When using the scanner glass, close the scanner lid to avoid dark edges on the scanned image.
- Do *not* load postcards, photos, small items, transparencies, photo paper, or thin media (such as magazine clippings) into the ADF. Place these items on the scanner glass.

Making copies



- 1 Load paper.
- 2 Load an original document faceup into the ADF or facedown on the scanner glass.
- 3 From the printer control panel, press .
- 4 Press the left or right arrow button to select the number of copies, and then press the **Color/Black** button to set a color or black-and-white copy.

When you select color or black-only printing, the light near your choice comes on.

- 5 Press .



Copying photos

- 1 Load photo paper.
- 2 Place a photo facedown on the scanner glass.

- 3 From the printer control panel, press .
- 4 Press the up or down arrow button to scroll to **Photo Reprint**.
- 5 Press the left or right arrow button to select the desired photo size.
- 6 Press .

Note: For best results, allow the prints to dry at least 24 hours before stacking, displaying, or storing.



Copying a two-sided document

- 1 Load paper.
- 2 Load an original document faceup into the ADF or facedown on the scanner glass.
- 3 From the printer control panel, press .
- 4 Press the up or down arrow button to scroll to **2-Sided Copies**.
- 5 Press the left or right arrow button to scroll to **2 to 1** or **2 to 2**.
 - Select 2 to 1 to make single-sided copies of the two-sided document.
 - Select 2 to 2 to make two-sided copies (like the original document).
- 6 Press .
- 7 Follow the instructions on the display.

Enlarging or reducing images

- 1 Load paper.
- 2 Load an original document facedown on the scanner glass.
- 3 From the printer control panel, press .
- 4 Press the up or down arrow button to scroll to **Resize**.
- 5 Press the left or right arrow button to select the setting that you want.



Notes:

- If you select Custom %, then press , and then press the left or right arrow button to select the desired custom percent value. Press  to save the setting.
- If you select Borderless, then the printer will reduce or enlarge the document or photo as necessary to print a borderless copy on the paper size that you selected. For best results with this resize setting, use photo paper and set the paper type to Photo, or let the printer automatically detect the paper type.



- 6 Press .

Note: After the copy job is finished, press  to reset the settings to the default. The resize setting also switches to 100% after two minutes of printer inactivity.

Adjusting copy quality

- 1 Load paper.
- 2 Load an original document faceup into the ADF or facedown on the scanner glass.
- 3 From the printer control panel, press .
- 4 Press the up or down arrow button to scroll to **Quality**.
- 5 Press the left or right arrow button to set the copy quality to Automatic, Draft, Normal, or Photo.
- 6 Press .

Making a copy lighter or darker

- 1 Load paper.
- 2 Load an original document faceup into the ADF or facedown on the scanner glass.
- 3 From the printer control panel, press .
- 4 Press the up or down arrow button to scroll to **Lighter/Darker**.
- 5 Press the left or right arrow button to adjust the slider.
Note: Pressing the left arrow button makes the copy lighter, and pressing the right arrow button makes the copy darker.
- 6 Press .

Collating copies using the printer control panel



If you print multiple copies of a document, then you can choose to print each copy as a set (collated) or to print the copies as groups of pages (not collated).

Collated





Not collated



- 1 Load paper.
- 2 Load an original document faceup into the ADF or facedown on the scanner glass.
- 3 From the printer control panel, press .
- 4 Press the left or right arrow button to select the number of copies, and then press .
- 5 Press the up or down arrow button to scroll to **Collate**.
- 6 Press the left or right arrow button to scroll to **On**.
- 7 Press .



Repeating an image on one page

You can print the same page image multiple times on one sheet of paper. This option is helpful when creating items such as labels, decals, flyers, and handouts.

- 1 Load paper.
- 2 Load an original document faceup into the ADF or facedown on the scanner glass.
- 3 From the printer control panel, press .
- 4 Press the up or down arrow button to scroll to **Copies per Sheet**.
- 5 Press the left or right arrow button to select the number of times that an image is repeated on a page: once, four times, nine times, or 16 times.
- 6 Press .

Copying multiple pages on one sheet

The Pages per Sheet setting lets you copy multiple pages on one sheet by printing smaller images of each page. For example, you can condense a 20-page document into five pages if you use this setting to print four page images per sheet.

- 1 Load paper.
- 2 Load an original document faceup into the ADF or facedown on the scanner glass.
- 3 From the printer control panel, press .
- 4 Press the up or down arrow button to scroll to **Pages per Sheet**.
- 5 Press the left or right arrow button to select the number of pages that you want to copy on a sheet of paper. You may choose to copy one, two, or four page images on a sheet.
Note: If you are copying four pages in landscape format, scan pages 3 and 4 first, and then scan pages 1 and 2.
- 6 Press .

Making a duplex copy

Making a duplex copy automatically

The automatic duplex unit, available only on selected printer models, supports letter- and A4-size paper. If you purchased a model without automatic duplex, or if you need to make duplex copies using other paper sizes, then see the instructions for making a duplex copy manually.

Note: You cannot make duplex copies on envelopes, card stock, or photo paper.

- 1 Load paper.
- 2 Load an original document faceup into the ADF or facedown on the scanner glass.
- 3 From the printer control panel, press .
- 4 Press the up or down arrow button to scroll to **2-Sided Copies**.

- 5 Choose the duplex option that matches your original document:
 - If you are copying a one-sided document, then press the left or right arrow button to scroll to 1 to 2.
 - If you are copying a two-sided document, then press the left or right arrow button to scroll to 2 to 2.
- 6 Press  to save the first page of the document to the printer memory.
- 7 Follow the instructions on the display.

Making a duplex copy manually

- 1 Load paper.
- 2 Load an original document faceup into the ADF or facedown on the scanner glass.
- 3 From the printer control panel, press .
- 4 Press the left or right arrow button to select the number of copies, and then press the **Color/Black** button to set a color or black-and-white copy.

When you select color or black-only printing, the light near your choice comes on.
- 5 Press  to print on one side of the paper.
- 6 Load the next page of the document:
 - If you are copying a one-sided document, then load the next page faceup into the ADF or facedown on the scanner glass.
 - If you are copying a two-sided document, then flip the original document, and then reload it faceup into the ADF or facedown on the scanner glass.
- 7 Remove the paper from the paper exit tray, and then reload the paper to print the other side of the document.

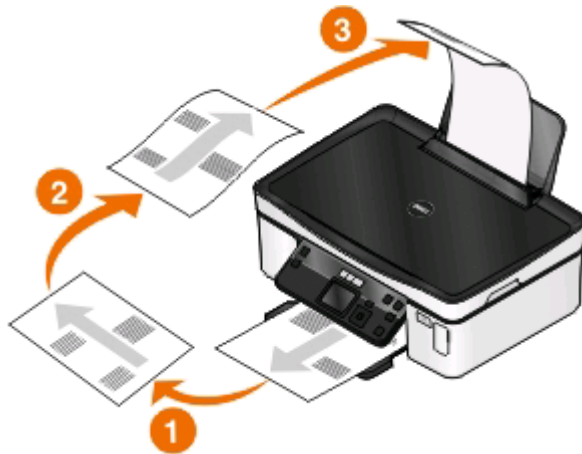

- 8 Press .

Canceling copy jobs

To cancel a copy job, press .

Scanning stops and the printer returns to the previous menu.



Scanning

Automatic Document Feeder (ADF)	Scanner glass
<p>Use the ADF for multiple-page documents.</p> <p>Note: The ADF is available only on selected models. If you purchased a printer without an ADF, then load original documents or photos on the scanner glass.</p>	 <p>Use the scanner glass for single pages, small items (such as postcards or photos), transparencies, photo paper, or thin media (such as magazine clippings).</p>

Tips for scanning

- When using the ADF, adjust the ADF paper guide to the width of the original document.
- When using the scanner glass, close the scanner lid to avoid dark edges on the scanned image.
- Do *not* load postcards, photos, small items, transparencies, photo paper, or thin media (such as magazine clippings) into the ADF. Place these items on the scanner glass.
- Select the PDF file type if you want to scan multiple pages and save them as one file.

Scanning to a local or network computer

- 1 Load an original document faceup into the ADF or facedown on the scanner glass.
 - 2 From the printer control panel, press .
 - 3 Press the left or right arrow button to scroll to **USB** or the name of the network computer, and then press .
- The local or network computer is the destination that will receive the scan. Wait until the printer has finished downloading a list of the scan applications available on the selected computer.

Notes:

- If the printer is connected only to a local computer, then the printer will automatically download a list of the scan applications.
- You may be prompted to enter a PIN if the computer requires it. Press the arrow buttons to enter the PIN. Press **OK** each time you enter a number.
- To assign a computer name and a PIN to the computer, see the Help for the printer software associated with your operating system.

- 4 Press the left or right arrow button to select an application, and then press **OK**.
- 5 Press the arrow buttons to select the resolution quality and the original image size. Press **OK** each time you make a selection.
- 6 Press  to start scanning.

The scan is complete when the application you selected in step 4 opens on the destination computer, and the scan appears within the application as a new file.

Scanning to a flash drive or memory card

Before you begin, make sure your flash drive or memory card is not write protected.

- 1 Load an original document faceup into the ADF or facedown on the scanner glass.
- 2 From the printer control panel, press .
- 3 Press the up or down arrow button to scroll to **Memory Device**.
- 4 Insert the flash drive or memory card, and then press **OK**.
- 5 Press the arrow buttons to select the resolution quality, the output file type you want to create, and the original image size. Press **OK** each time you make a selection.

Note: Select the PDF file type if you want to scan multiple pages and save them as one file.

- 6 Press  to start scanning.

The scan is complete when a message appears on the printer control panel indicating that the file you scanned has been saved.

Scanning photos into an editing application

For Windows users

- 1 Load a photo or photos.
- 2 Click  or **Start**.
- 3 Click **All Programs** or **Programs**, and then select the printer program folder from the list.
- 4 Navigate to:

Printer Home > select your printer > **Photo**

- If you want to scan a single photo, or multiple photos as a single image, then select **Single photo**.
- If you want to scan multiple photos at once and save them as separate images, then select **Split into individual photos**.

Note: Allow at least 1/4 inch of space between photos if you want to scan multiple photos at once and save them as separate images.

Scanning starts and the scan progress dialog appears.

5 Save the photo or photos, and open them in a photo editing application to edit.

For Macintosh users

1 Load a photo or photos.

2 From the Finder desktop, double-click the printer program folder.

3 Double-click the printer Center to open the All-In-One Center.

4 From the “What is being scanned?” area of the All-In-One Center, select **Photo**.

5 From the “How will the scanned image be used?” pop-up menu, choose **To be printed** or **To be viewed on monitor/Web page**.

6 From the “Send scanned image to” menu, choose a destination folder or application for the scanned image.

7 If you have several images to scan, then select **Prompt for multiple pages**.

8 Click **Preview/Edit**.

The Scan dialog appears.

9 Adjust the image and scan settings as needed.

10 Click **Scan**.

Scanning documents into an editing application

An Optical Character Recognition (OCR) application allows you to edit an original text document that has been scanned. In order for this to work, you must have an OCR application installed on a local or network computer, and you must be able to choose it from the list of applications when you set up the scan.

When selecting settings for the scan:

- Select to scan to the local computer or network computer where the OCR application is installed.
- Select to scan to the highest resolution.

For Windows users

1 Load an original document.

2 Click  or **Start**.

3 Click **All Programs** or **Programs**, and then select the printer program folder from the list.

- 4 Navigate to:
Printer Home > select your printer > **Document**
Scanning starts and the scan progress dialog appears.
- 5 When the scan is finished, save the document in a word-processing application.
- 6 Open the document in the selected application to edit it.

For Macintosh users

- 1 Load an original document.
- 2 From the Finder desktop, double-click the printer program folder.
- 3 Double-click the printer Center to open the All-In-One Center.
- 4 From the “What is being scanned?” area of the All-In-One Center, select a document type other than Photo.
- 5 From the “How will the scanned image be used?” pop-up menu, choose **To be edited (OCR)**.
- 6 From the “Send scanned image to” menu, choose a word-processing application to use for editing.
- 7 Click **Scan**.
- 8 Open the scanned document from a word-processing application to edit it.

Scanning directly to e-mail using the printer software

For Windows users

- 1 Load an original document.
- 2 Click  or **Start**.
- 3 Click **All Programs** or **Programs**, and then select the printer program folder from the list.
- 4 Navigate to:
Printer Home > select your printer > **E-mail**
- 5 Select **Photo**, **Document**, or **PDF**.
Note: You can select Document only if an OCR application is installed on your computer.
Scanning starts and the scan progress dialog appears.
- 6 When the scan is finished, a new e-mail message is created with the scanned document automatically attached.
- 7 Compose your e-mail message.

Note: If your e-mail program does not open automatically, then you can scan the document to the computer and then send it through e-mail as an attachment.

For Macintosh users

- 1 Load an original document.
- 2 From the Finder desktop, double-click the printer program folder.
- 3 Double-click the printer Center to open the All-In-One Center.
- 4 From the “What is being scanned?” area of the All-In-One Center, select a document type.
- 5 From the “How will the scanned image be used?” menu, choose **To be viewed on monitor/Web page**.
- 6 From the “Send scanned image to” menu, choose an application.
- 7 Click **Scan**.
- 8 Retrieve the scanned image from the application, and then send it through e-mail as an attachment.

Scanning to a PDF

For Windows users

- 1 Load an original document.
- 2 Click  or **Start**.
- 3 Click **All Programs** or **Programs**, and then select the printer program folder from the list.
- 4 Navigate to:
Printer Home > select your printer > **PDF**
Scanning starts and the scan progress dialog appears.
- 5 Save the document as a PDF.

For Macintosh users

- 1 Load an original document.
- 2 From the Finder desktop, double-click the printer program folder.
- 3 Double-click the printer Center to open the All-In-One Center.
- 4 From the “What is being scanned?” area of the All-In-One Center, choose a document type.
- 5 Customize the settings as needed.
- 6 Click **Scan**.
- 7 Save the document as a PDF.

Scanning FAQ

How can I improve the quality of a scan?

- Make sure your original documents are in good condition.
- Make sure the application that receives the scanned document is appropriate. For example, if you are scanning a photo to edit it, then make sure you choose a photo editing application to receive the scan. If you are scanning a document to edit the text, then make sure you choose an OCR application.
- Use a high resolution.

How do I scan in black and white?

Color is the default for all scans. To scan in black and white, press the **Color/Black** button on the printer control panel to switch from color to black and white.

Why am I being asked for a PIN?

PINs are a security measure used to restrict the scanned information from going into certain locations, or to keep what is being scanned from being seen or used by others. You may be prompted to enter a PIN if the network computer you are scanning to requires one.

To learn how PINs get assigned to network computers, see the Help for the printer software associated with your operating system.

What is an application list, and how do I update it?

When you scan a file, you can choose which application to use to open it on your computer. The printer downloads this application list from your computer when scanning for the first time. If you do not see the application you want on the list, or if you install new applications on your computer, then update the application list in the printer.

Updating the application list

- 1 From the printer control panel, press .
- 2 Press the arrow buttons to scroll to **Computer** or **Network**.
- 3 Select a local or network computer to receive the scan and then press **OK**.
Wait until the printer has finished downloading a list of the scan applications available on the selected computer.
- 4 Select **REFRESH** from the list of scan applications.
This updates the application list in the printer.

Canceling scan jobs

Press **X** on the printer control panel, or click **Cancel** on the computer screen.

Networking

Installing the printer on a wireless network

Wireless network compatibility

Your printer may contain an IEEE 802.11b, IEEE 802.11g, or IEEE 802.11n wireless print server. Your printer is compatible with IEEE 802.11 b/g/n routers that are Wi-Fi certified.

Note: If your printer has an IEEE 802.11g wireless print server and you are having issues with an n router, then verify with your router manufacturer that the current mode setting is compatible with g devices, as this setting varies depending on the router brand or model.

Supported network security options

The printer supports three wireless security options: no security, WEP, and WPA/WPA2.

No Security

It is not recommended to use no security at all on a home wireless network. Using no security means that anyone within range of your wireless network can use your network resources—including Internet access—if your wireless network is connected to the Internet. The range of your wireless network may extend far beyond the walls of your home, allowing access to your network from the street or from your neighbors' homes.

WEP

WEP (Wired Equivalent Privacy) is the most basic and the weakest type of wireless security. WEP security relies on a series of characters called the WEP key.

Every device on the wireless network must use the same WEP key. WEP security can be used on both ad hoc and infrastructure networks.

A valid WEP key has:

- Exactly 10 or 26 hexadecimal characters. Hexadecimal characters are A–F, a–f, and 0–9.
- or*
- Exactly 5 or 13 ASCII characters. ASCII characters are letters, numbers, punctuation, and symbols found on a keyboard.

WPA/WPA2

WPA (Wi-Fi Protected Access) and *WPA2* (Wi-Fi Protected Access 2) offer stronger wireless network security than WEP. WPA and WPA2 are similar types of security. WPA2 uses a more complex encryption method and is more secure than WPA. Both WPA and WPA2 use a series of characters, called the WPA pre-shared key or passphrase, to protect wireless networks from unauthorized access.

A valid WPA passphrase has:



- Exactly 64 hexadecimal characters. Hexadecimal characters are A–F, a–f, and 0–9.
or
- From 8 to 63 ASCII characters. ASCII characters are letters, numbers, punctuation, and symbols found on a keyboard. ASCII characters in a WPA passphrase are case-sensitive.

Every device on the wireless network must use the same WPA passphrase. WPA security is an option only on infrastructure networks with access points (wireless routers) and network cards that support WPA. Most newer wireless network equipment also offer WPA2 security as an option.

Note: If your network uses WPA or WPA2 security, then select **WPA Personal** when you are prompted to select the type of security your network uses.

Printing a network setup page

A *network setup page* lists the configuration settings of the printer, including the IP address and MAC address of the printer.

- 1 Load plain paper.
- 2 From the printer control panel, press .
- 3 Press the arrow buttons to scroll to **Network Setup**, and then press .
- 4 Press  to select **Print Setup Page**.
The network setup page prints.

Information you will need to set up the printer on a wireless network

To set up the printer for wireless printing, you need to know:

- The name of your wireless network, which is also known as the *SSID* (Service Set Identifier)
- If encryption was used to secure your network
- The security key (either a WEP key or WPA/WPA2 passphrase)

To locate the network WEP key or WPA/WPA2 passphrase, view your access point (wireless router) settings and check the security information.

If your access point is using WEP security, then the WEP key should be:

- Exactly 10 or 26 hexadecimal characters. Hexadecimal characters are A–F, a–f, and 0–9.
or
- Exactly 5 or 13 ASCII characters. ASCII characters are letters, numbers, punctuation, and symbols found on a keyboard.

If your access point is using WPA or WPA2 security, then the WPA passphrase should be:

- Exactly 64 hexadecimal characters. Hexadecimal characters are A–F, a–f, and 0–9.
or
- From 8 to 63 ASCII characters. ASCII characters are letters, numbers, punctuation, and symbols found on a keyboard. ASCII characters in a WPA passphrase are case-sensitive.

If your wireless network is not using security, then you will not have a security key.

Note: If you do not know the SSID of the network that your computer is connected to, then launch the wireless utility of the computer network adapter and look for the network name. If you cannot find the SSID or the security information for your network, then see the documentation that came with the access point, or contact your system support person.

Installing the printer on a wireless network

Before you install the printer on a wireless network, make sure that:

- Your wireless network is set up and working properly.
- The computer you are using is connected to the same wireless network where you want to set up the printer.

For Windows users

- 1 Close all open software programs.
- 2 Insert the installation software CD.

If the Welcome screen does not appear after a minute, then launch the CD manually:

- a Click , or click **Start** and then click **Run**.
 - b In the Start Search or Run box, type `D:\setup.exe`, where **D** is the letter of your CD or DVD drive.
 - c Press **Enter**, or click **OK**.
- 3 Follow the instructions on the Welcome screen to set up the printer.

For Macintosh users

- 1 Close all open applications.
- 2 Download the latest installer from the printer Web site.
- 3 Launch the printer installation software, and then follow the instructions on the computer screen.

Installing the printer on other computers

Once the printer is set up on the wireless network, it can be accessed wirelessly by any other computer on the network. However, you will need to install the printer driver on every computer that will access it. You do not need to configure the printer again, although you will need to run the setup software on each computer to install the driver.

For Windows users

- 1 Close all open software programs.
- 2 Insert the installation software CD.

If the Welcome screen does not appear after a minute, then launch the CD manually:

- a Click , or click **Start** and then click **Run**.
 - b In the Start Search or Run box, type `D:\setup.exe`, where **D** is the letter of your CD or DVD drive.
 - c Press **Enter**, or click **OK**.
- 3 Follow the instructions on the computer screen for installing a configured printer on a new computer.

For Macintosh users

- 1 Close all open applications.
- 2 Download the latest installer from the printer Web site.
- 3 Launch the printer installation software, and then follow the instructions on the computer screen.

Interpreting the colors of the Wi-Fi indicator light

The colors of the Wi-Fi indicator light show the network status of the printer.

- **Off** means one of the following:
 - The printer is turned off or is powering up.
 - The printer is not connected to a wireless network and is in Power Saver mode. In Power Saver mode, the power light pulses on and off.
- **Solid orange** means one of the following:
 - The printer has not yet been configured for a wireless network.
 - The printer is configured for an ad hoc connection, but it is not currently communicating with another ad hoc device.
- **Blinking orange** means one of the following:
 - The printer is out of the range of the wireless access point (wireless router).
 - The printer is trying to communicate with the wireless access point, but the wireless access point is turned off or not working properly.
 - Either the configured printer or the wireless access point has been turned off and back on, and the printer is trying to establish communications with the network.
 - The wireless settings of the printer may no longer be valid.
- **Green** means that the printer is connected to a wireless network and is ready for use.

Special wireless installation instructions

The following instructions apply to customers outside of North America who are using a wireless broadband box. Some examples of these boxes include LiveBox, AliceBox, N9UF Box, FreeBox, and Club Internet.

Before you begin

- Make sure your box is wireless-enabled and activated to work on a wireless network. For more information about configuring the box to work wirelessly, see the documentation that came with your box.
- Make sure your box is turned on and that your computer is on and connected to your wireless network.

Adding the printer to your wireless network

- 1 Set up your printer for wireless networking using the setup instructions provided.
Stop when you are prompted to select a network.
- 2 If there is an association/registration button on the back of your box, then press it before selecting a network.
Note: After pressing the association/registration button, you have five minutes to complete the printer installation.
- 3 Return to the computer screen.

From the wireless networks list that appears, select your network, and then click **Continue**.

If your wireless network does not appear in the list:

- a Connect to another wireless network.

For Windows users

Click **Unlisted Network**.

For Macintosh users

Select **Other Wireless Network** from the list, and then click **Continue**.

- b Enter the details about your wireless network.

Note: Your WEP, WPA, or WPA2 key may be obtained from the bottom of the box, the documentation that came with the box, or from the box Web page. If you have already changed the key for your wireless network, then use the key you created.

- 4 Follow the instructions on the computer screen.

Assigning a static IP address

The printer will be assigned an IP address automatically through DHCP on most wireless networks.

- 1 Complete the wireless setup, allowing the printer to receive a DHCP address from a DHCP server on the network.
- 2 Print a network setup page to see the IP address currently assigned to the printer.
- 3 Open a Web browser and then type the printer IP address in the address field. Press **Enter**.

Note: If you are using a proxy server, then temporarily disable it to load the printer Web page correctly.

- 4 Click **Configuration > TCP/IP > Set static IP address**.
- 5 In the Address field, type the IP address you want to assign to the printer, and then click **Submit**.

To verify, type the static IP address in the Web browser address field, and then press **Enter**.

For more information, contact your system support person.

Changing wireless settings after installation

To change wireless settings on the printer, such as the configured network and the security key, do the following:

For Windows users

- 1 Click  or **Start**.
- 2 Click **All Programs** or **Programs**, and then select the printer program folder from the list.
- 3 Navigate to:
Printer Home > select your printer > Settings tab > Wireless setup utility
- 4 Follow the instructions on the computer screen.

For Macintosh users

- 1 From the Finder, navigate to:
Applications > select your printer folder
- 2 Double-click **Wireless Setup Assistant**.
- 3 Follow the instructions on the computer screen.

Advanced wireless setup

Creating an ad hoc wireless network

You can set up an ad hoc network if you:

- Do not have an access point or wireless router
- Do not have a wireless network (but do have a wireless network adapter for your computer)
- Want to set up a standalone network between the printer and a computer with a wireless network adapter

Notes:

- Before you begin, make sure your wireless network adapter is properly attached to your computer and is working.
- The recommended way to set up your wireless network is to use an access point (wireless router). This network setup is called *infrastructure network*.
- If your computer has *MyWi-Fi* or *Wi-Fi Direct*, then you can create direct connections to your wireless printer. For more information, see the documentation that came with your computer.
- The printer can communicate on only one wireless network at a time. Configuring the printer for an ad hoc wireless network will keep it from working on any other wireless network, either ad hoc or infrastructure.

In Windows Vista or later

- 1 Click  > **Control Panel** > **Network and Internet** > **Network and Sharing Center**.
- 2 Click **Set up a connection or network** > **Set up a wireless ad-hoc (computer-to-computer) network** > **Next**.
- 3 Follow the instructions for setting up a wireless ad hoc network. As part of the setup:
 - a Create a network name or SSID for the network between the computer and your printer.
 - b Write down the name of your network. Make sure you copy it exactly, including any capital letters.
 - c Go to the Security Type list, select **WPA2-Personal** or **WEP**, and then create a WPA passphrase or WEP key.

WPA passphrases must be:

- From 8 to 63 ASCII characters. ASCII characters are letters, numbers, and symbols found on a keyboard. ASCII characters in a WPA passphrase are case-sensitive.
or
- Exactly 64 hexadecimal characters. Hexadecimal characters are A–F, a–f, and 0–9.

WEP keys must be:

- Exactly 5 or 13 ASCII characters. ASCII characters are letters, numbers, and symbols found on a keyboard.
or
- Exactly 10 or 26 hexadecimal characters. Hexadecimal characters are A–F, a–f, and 0–9.

d Write down the password for your network. Make sure you copy it exactly, including any capital letters.

Windows Vista will enable the ad hoc network for you. It will appear in the “Connect to a network” dialog under “Available networks,” indicating that the computer is configured for the ad hoc network.

4 Close the Windows Control Panel and any remaining windows.

5 Insert the installation software CD, and follow the instructions for wireless installation.

Note: Do not connect the installation or network cables until instructed to do so by the setup software.

6 When the available networks are displayed, provide the network name and the security information you created. The installer will configure the printer for use with your computer.

7 Store a copy of your network name and security information in a safe place for future reference.

Note: You may need to reconnect Windows Vista computers to the ad hoc network after restarting.

In Windows XP

1 Click **Start > Control Panel > Network and Internet Connections > Network Connections**.

2 Right-click the icon for your wireless network connection.

3 Click **Enable**, if it appears in the pop-up menu.

Note: If Disable appears, then your wireless connection is already enabled.

4 Right-click the **Wireless Network Connection** icon.

5 Click **Properties > Wireless Networks** tab.

Note: If the Wireless Networks tab does not appear, then your computer has third-party software that controls your wireless settings. You must use that software to set up the ad hoc wireless network. For more information, see the documentation for the third-party software.

6 Select the **Use Windows to configure my wireless network settings** check box.

7 Under Preferred Networks, delete any existing networks.

Select a network, and then click **Remove** to delete the network from the list.

8 Click **Add** to create an ad hoc network.

9 In the Network Name (SSID) box, type the name you want to give your wireless network.

10 Write down the network name you chose so you can refer to it when running the wireless setup. Make sure you copy it exactly, including any capital letters.

11 If Network Authentication appears in the list, then select **Open**.

12 In the “Data encryption” list, select **WEP**.

13 If necessary, clear the “The key is provided for me automatically” check box.

14 In the Network Key box, type a WEP key.

- 15** Write down the WEP key you chose so you can refer to it when running the wireless setup. Make sure you copy it exactly, including any capital letters.
- 16** In the “Confirm network key” box, type the same WEP key.
- 17** Select **This is a computer-to-computer (ad hoc) network; wireless access points are not used.**
- 18** Click **OK** twice to close the two open windows.
- 19** It may take a few minutes for your computer to recognize the new settings. To check the status of your network:
 - a** Right-click the **Wireless Network Connections** icon.
 - b** Select **View Available Wireless Networks**.
 - If the network is listed but the computer is not connected, select the ad hoc network, and then click **Connect**.
 - If the network does not appear, wait a moment, and then click **Refresh network list**.
- 20** Insert the installation software CD, and then follow the instructions for wireless installation.

Note: Do *not* connect the installation or network cables until instructed to do so by the setup software.
- 21** When the available networks are displayed, provide the network name and the security information you created. The installer will configure the printer for use with your computer.
- 22** Store a copy of your network name and security information in a safe place for future reference.

In Windows 2000

- See the documentation that came with your wireless network adapter for information on configuring an ad hoc network with Windows 2000.

For Macintosh users

- 1** Access the Airport settings:

In Mac OS X version 10.5 or later

From the Apple menu, navigate to:

System Preferences > Network > AirPort

In Mac OS X version 10.4 or earlier

From the Finder, navigate to:

Applications > Internet Connect > AirPort

- 2** From the Network Name or Network menu, click **Create Network**.
- 3** Create a name for the ad hoc network, and then click **OK**.

Note: Store the network name and password in a safe place for future reference.

Adding a printer to an existing ad hoc wireless network

Note: The printer can communicate on only one wireless network at a time. Configuring the printer for an ad hoc wireless network will remove it from any other wireless network, either ad hoc or infrastructure, for which it is configured.

For Windows users

- 1 Click  or **Start**.
- 2 Click **All Programs** or **Programs**, and then select the printer program folder from the list.
- 3 Navigate to:
Printer Home > select your printer > **Settings** tab > **Wireless setup utility**
- 4 Follow the instructions on the computer screen.

Note: Windows Vista computers may need to be reconnected to the ad hoc network after restarting.

For Macintosh users

- 1 From the Finder, navigate to:
Applications > select your printer folder
- 2 Double-click **Wireless Setup Assistant**.
- 3 Follow the instructions on the computer screen.

Configuring the printer wirelessly using WPS (Windows only)

With *Wi-Fi Protected Setup* (WPS), it is easy to add computers or printers to your wireless network because the SSID and WPA passphrase are automatically detected and configured for you.

- 1 Make sure your access point (wireless router) supports WPS.
- 2 Insert the installation software CD and follow the instructions on the computer screen.

Notes:

- If you are using the PIN method to add your printer using WPS, then make sure you type all eight digits when you are asked to enter your PIN.
- To use WPS to configure the printer wirelessly, all of the devices on your wireless network must support WPS. If any device on your network does not support WPS, then you must type the SSID and security information when prompted.

Switching between USB and wireless connections (Windows only)

You can change the way you access your printer, depending on your needs. The following procedures assume that you have configured your printer for one type of connection and that the printer drivers are installed on the computer. See related topics on troubleshooting-specific connection types if you encounter difficulties during configuration.

Switching to a wireless connection

- 1 Click  or **Start**.
- 2 Click **All Programs** or **Programs**, and then select the printer program folder from the list.
- 3 Navigate to:
Printer Home > select your printer > **Settings** tab > **Wireless setup utility**
- 4 Follow the instructions on the computer screen.

Note: There is no need to remove the USB cable connecting the printer to the computer during wireless configuration.

Switching to a local (USB) connection

- 1 Attach a USB cable to the computer and to the printer.
- 2 Wait a moment for Windows to locate the driver and finish setting up the printer.

Note: You can continue to use the printer wirelessly.

Switching between USB and wireless connections (Macintosh only)

You can change the way you access your printer depending on your needs. The procedures below assume that you have configured your printer for one type of connection. See related topics on troubleshooting-specific connection types if you encounter difficulties during configuration.

Switching to a wireless connection

- 1 Close all open applications.
- 2 Download the latest installer from the printer Web site.
- 3 Double-click **Dell Extras** > **Dell Setup Assistant**.
- 4 Follow the instructions on the computer screen for configuring the printer wirelessly.

Note: There is no need to remove the USB cable connecting the printer to the computer during wireless configuration.

Switching to a local (USB) connection

- 1 Attach one end of a USB cable to the USB port on the back of the printer. Attach the other end to a USB port on the computer.
- 2 Add the printer:

In Mac OS X version 10.5 or later

- a From the Apple menu, navigate to:
System Preferences > **Print & Fax**
- b Click **+**.
- c Click **Default** tab > select your printer > **Add**.

In Mac OS X version 10.4 or earlier

- a From the Finder, choose **Utilities**.
- b Double-click **Printer Setup Utility** or **Print Center**.

- c** From the Printer List dialog, choose the printer you want to use, and then click **Add**.
 - d** From the Printer Browser, select your printer, and then click **Add**.
- 3** A second print queue will be created. Remove the wireless queue if you do not want to switch back to accessing the printer over a wireless connection.

Sharing a printer in a Windows environment

- 1** Prepare the computers to share the printer:
 - a** Make all computers printing to the printer accessible through Network Neighborhood by enabling File and Print Sharing. See the Windows documentation for instructions on enabling File and Print Sharing.
 - b** Install the printer software on all computers that will print to the printer.
- 2** Identify the printer:
 - a** On the computer that is attached to the printer, do one of the following:
 - 1** Click , or click **Start** and then click **Run**.
 - 2** In the Start Search or Run box, type `control printers`.
 - 3** Press **Enter**, or click **OK**.
 - b** Right-click the name of your printer.
 - c** Click **Sharing** or **Printer Properties**.
 - d** From the Sharing tab, select **Share this printer** or **Shared as**.
 - e** Assign a distinctive name, and then click **OK**.
- 3** Locate the printer from the remote computer:

Note: The remote computer is the one that is not attached to the printer.

 - a** Do one of the following:
 - 1** Click , or click **Start** and then click **Run**.
 - 2** In the Start Search or Run box, type `control printers`.
 - 3** Press **Enter**, or click **OK**.
 - b** Right-click the name of your printer.
 - c** Click **Properties** or **Printer properties**.
 - d** Click **Ports** > **Add Port** > **Local Port** > **New Port**.
 - e** Type the **Universal Naming Convention (UNC) Port Name**, which consists of the server name and the distinctive printer name that was specified in step 2 on page 70. The name should be in the form `\\server\printer`.
 - f** Click **OK**.
 - g** Click **Close** on the Printer Ports dialog.
 - h** Make sure the new port is selected on the Ports tab, and then click **Apply**.
 - i** Click **OK**.

Sharing a printer in a Macintosh environment

- 1 From the Finder, choose **Help > Mac Help**.
- 2 In the Search field, type `sharing the printer on a network`, and then press **return**.
- 3 Select only *one* of the following:
 - **Sharing your printer with Mac OS X users**—Let other Macintosh computers on the network that use Mac OS X version 10.4 or later use any printer connected to your Macintosh computer.
 - **Sharing your printer with Windows users**—Let Windows computers on the network use any printer connected to your Macintosh computer.
- 4 Follow the instructions on the computer screen.

Note: Windows users should see the Windows documentation for information on adding a network printer connected to a Macintosh computer.

Networking FAQ

What is Wi-Fi Protected Setup?

Wi-Fi Protected Setup (WPS) is a simple and secure configuration that allows you to establish a wireless home network and enable network security without requiring prior knowledge of Wi-Fi technology. It is no longer necessary to configure the network name (SSID) and WEP key or WPA passphrase for network devices.

Note: WPS supports only networks that communicate through access points (wireless routers).

The printer supports the following methods in connecting to a wireless network:

- *Personal Identification Number (PIN)*—A PIN on the printer is entered into the wireless settings of the access point.
- *Push Button Configuration (PBC)*—Buttons on both the printer and the access point are pushed within a given period of time.

Look for any of these identifier marks to check if your access point is WPS certified:



You can find these WPS logos on the side, back, or top of your access point.

For more information on accessing the wireless settings and determining the WPS capability of your access point, see the documentation that came with the access point or contact your system support person.

Where do I find my WEP key or WPA passphrase?

- Contact your system support person.
 - The person who set up your network usually keeps the WEP key or WPA passphrase.
 - If your wireless network was set up by your *Internet Service Provider (ISP)*, then you might find the information in the documentation they provided.

- See the documentation that came with your access point (wireless router).
If your access point is using the default settings, then you can find the information in the documentation.
- View the security settings on the access point.
 - 1 Open a Web browser, and then type the IP address of the access point in the address field.

Notes:

- To obtain the IP address of the access point, see the documentation that came with it or contact your system support person.
- If you are using a proxy server, then temporarily disable it to load the Web page correctly.

- 2 Enter the user name and password for the access point when prompted.

Note: The WEP key or WPA passphrase is not the same as the password for the access point. The password allows you to access the access point settings. The WEP key or WPA passphrase allows printers and computers to join your wireless network.

- 3 Look for the WEP key or WPA passphrase.

What is an SSID?

A *Service Set Identifier* (SSID) is the name that identifies a wireless network. All devices on the network must know the SSID of the wireless network or they will not be able to communicate with each other. Usually, the wireless network broadcasts the SSID to allow wireless devices in the area to connect to it. Sometimes, the SSID is not broadcast for security reasons.

An SSID can contain up to 32 alphanumeric characters.

Where do I find my SSID?

- View the settings on the access point (wireless router).
Most access points have a built-in Web server that can be accessed using a Web browser.
- Check your computer to see if a program was installed with your wireless network adapter.
Many network adapters provide a software application that allows you to view the wireless settings of your computer, including your SSID.

If you are unable to locate your SSID using either of these methods, then contact your system support person.

What is a network?

A network is a collection of devices such as computers, printers, Ethernet hubs, access points, and routers connected together for communication through cables or through a wireless connection. A network can be wired, wireless, or designed to have both wired and wireless devices.

How do I find out what type of security my network is using?

- Contact your system support person.
The person who set up your network usually keeps your wireless information.
- See the documentation that came with your access point (wireless router).
- Check the characters of the password that you use to access your wireless network.

If you are not using a password, then choose **No Security**.

Characters	Security type
Exactly 10 or 26 hexadecimal characters <i>or</i> Exactly 5 or 13 ASCII characters	WEP
Exactly 64 hexadecimal characters <i>or</i> From 8 to 63 ASCII characters	WPA or WPA2

Notes:

- Hexadecimal characters are A–F, a–f, and 0–9.
- ASCII characters are letters, numbers, and symbols found on a keyboard.
- View the security settings on the access point.

1 Open a Web browser, and then type the IP address of the access point in the address field.

Notes:

- To obtain the IP address of the access point, see the documentation that came with it, or contact your system support person.
- If you are using a proxy server, then temporarily disable it to load the Web page correctly.

2 Enter the user name and password for the access point when prompted.

Note: The WEP key or WPA passphrase is not the same as the password for the access point. The password allows you to access the access point settings. The WEP key or WPA passphrase allows printers and computers to join your wireless network.

3 Look for the WEP key or WPA passphrase.

How are home networks configured?

For desktop computers, laptops, and printers to communicate with each other over a network, they must be connected by cables and/or have wireless network adapters built in or installed in them.

There are many different ways a network can be set up. Four common examples appear below.

Note: The printers in the following diagrams represent printers with internal print servers built into them so that they can communicate over a network.

Wireless network examples

Scenario 1: Mixed wired and wireless connections on a network with Internet access

- All computers and printers connect to the network through a router with Ethernet and wireless capabilities.
- Some computers and printers connect wirelessly to the router; others connect over a wired connection.

- The network is connected to the Internet through a DSL or cable modem.

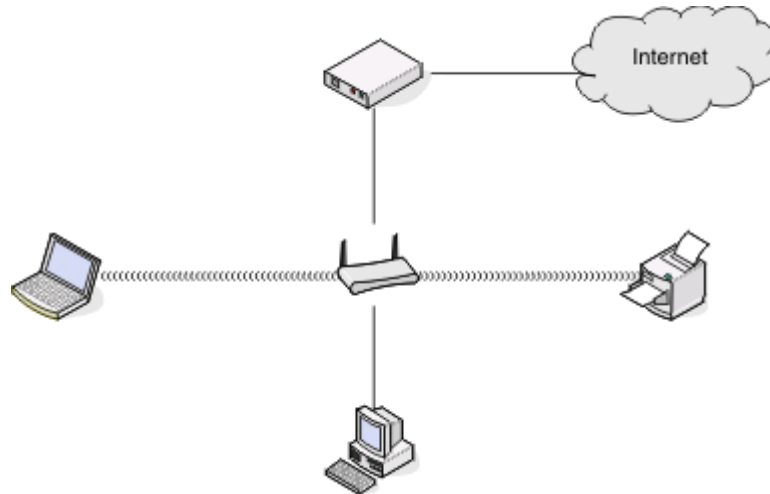

Scenario 2: Wireless network with Internet access

- All computers and printers connect to the network using a wireless access point or wireless router.
- The wireless access point connects the network to the Internet through a DSL or cable modem.

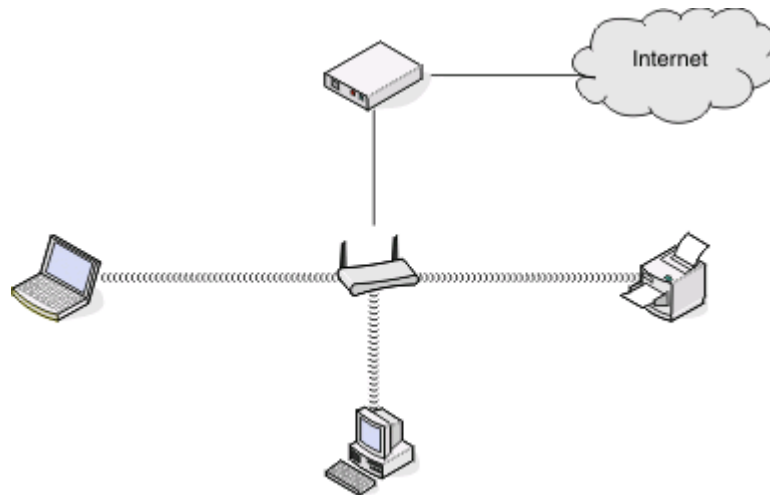

Scenario 3: Wireless network with no Internet access

- Computers and printers connect to the network using a wireless access point.
- The network has no connection to the Internet.

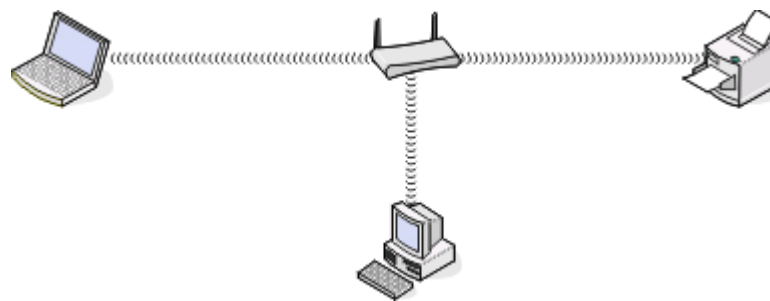

Scenario 4: Computer connected wirelessly to a printer without Internet access

- A computer is directly connected to a printer without going through a wireless router.
- This configuration is referred to as an *ad hoc network*.
- The network has no connection to the Internet.

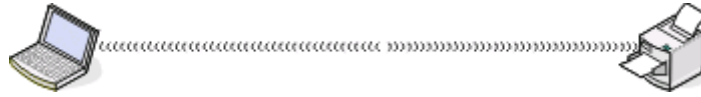

Note: Most computers can connect to only one wireless network at a time. If you access the Internet over a wireless connection, you will lose Internet access if you are connected to an ad hoc network.

Why do I need an installation cable?

When setting up the printer on your wireless network, the printer will need to temporarily connect to a computer using the installation cable. This temporary connection is used to set up the wireless settings of the printer.

How do I attach the installation cable?

The installation cable attaches to a USB port on the computer and to the square connector on the back of the printer. This connection allows you to configure the printer for a networked or locally attached installation.

- 1 Attach the large, rectangular connector to any USB port on your computer. USB ports may be on the front or the back of the computer, and may be horizontal or vertical.

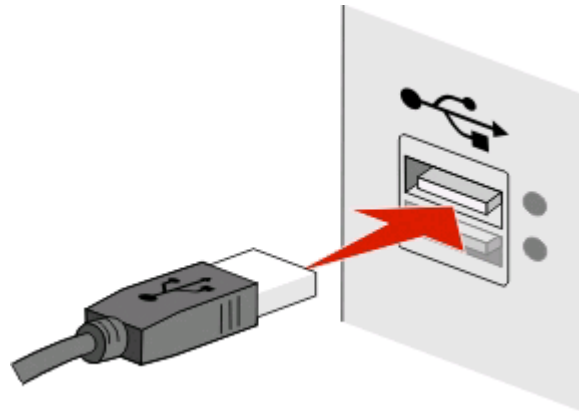

2 Attach the small, square connector to the back of the printer.

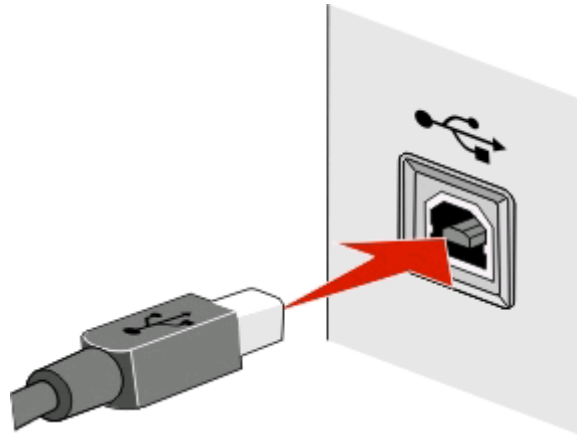

3 Continue following the on-screen instructions.

How are infrastructure and ad hoc networks different?

Wireless networks can operate in one of two modes: infrastructure or ad hoc.

In *infrastructure* mode, all devices on a wireless network communicate with each other through an access point (wireless router).

In *ad hoc* mode, a computer with a wireless network adapter communicates directly with a printer equipped with a wireless print server.

	Infrastructure	Ad hoc
Characteristics		
Communication	Through an access point	Directly between devices
Security	More security options	WEP or no security
Range	Determined by the range and number of access points	Restricted to the range of individual devices on the network
Speed	Usually faster	Usually slower
Requirements for all devices		
Unique IP address for each device	Yes	Yes
Mode set to	Infrastructure mode	Ad hoc mode
Same SSID	Yes, including the access point	Yes
Same channel	Yes, including the access point	Yes

We recommend setting up a network in infrastructure mode using the installation software CD. Infrastructure mode provides:

- Increased network security
- Increased reliability
- Faster performance
- Easier setup

Finding the signal strength

Wireless devices have built-in antennas that transmit and receive radio signals. The signal strength listed on the printer network setup page indicates how strongly a transmitted signal is being received. Many factors can affect the signal strength. One factor is interference from other wireless devices or other devices such as microwave ovens. Another factor is distance. The farther two wireless devices are from each other, the more likely it is that the communication signal will be weaker.

The strength of the signal received by your computer can also affect the connectivity of the printer with the network during configuration. When you installed the wireless adapter in your computer, the adapter software probably placed an icon in your system tray. Try double-clicking this icon, and it will tell you how strongly the computer is receiving the wireless signal from the network.

To improve signal quality, remove sources of interference and/or move wireless devices closer to the wireless access point (wireless router).

How can I improve wireless signal strength?

A common reason wireless printers fail to communicate over a network is poor wireless signal quality. If the signal is too weak, too distorted, or blocked by an object, it cannot carry information between the access point and the printer. To determine if the printer is receiving a strong signal from the access point, print a network setup page. The Quality field indicates the relative strength of the wireless signal the printer is receiving. Drops in signal strength can be intermittent, however, and although the signal quality appears high, it may drop during certain conditions.

If you think signal strength is a problem between your access point (wireless router) and the printer, then try one or more of the following:

Notes:

- The solutions below are for infrastructure networks. If you are using an ad hoc network, then adjust the computer when the solution suggests adjusting the access point.
- Ad hoc networks have a much shorter range than infrastructure networks. Try moving the printer closer to the computer if they seem to have trouble communicating.

MOVE THE PRINTER CLOSER TO THE ACCESS POINT

If the printer is too far away from the access point, then it will not be able to communicate with other devices on the network. For most indoor wireless networks, the maximum distance between the access point and the printer is approximately 100 feet (30 meters). This distance could be longer or shorter, depending upon the layout of the network and the limitations of the access point.

REMOVE OBSTACLES BETWEEN THE ACCESS POINT AND THE PRINTER

The wireless signal from your access point will pass through most objects. Most walls, floors, furniture, and other objects will not block the wireless signal. However, there are materials that are too dense for the signal to pass through, such as objects containing metal and concrete. Arrange your printer and access point so that the signal is not blocked by such objects.

REMOVE SOURCES OF INTERFERENCE

Other types of radio frequencies can cause problems with the wireless signal on your network, resulting to printing issues that seem to come and go.

- Turn off potential sources of interference where possible.
- Avoid using microwave ovens, cordless phones (but not cellular phones), baby monitors, almost any kitchen appliance, wireless surveillance equipment, or any appliance containing a motor when printing over your wireless network.
- If another wireless network is operating in the vicinity, then change the wireless channel on the access point.
- Do not place your access point on a printer or other electronic device. Such devices can also interfere with the wireless signal.

ARRANGE THE NETWORK TO REDUCE SIGNAL ABSORPTION

Even when the wireless signal is able to pass through an object, it is slightly weakened. If it passes through too many objects, then it can be significantly weakened. All objects absorb part of the wireless signal when it passes through them, and certain types of objects absorb enough to cause communications problems. Place your access point as high in the room as possible to avoid signal absorption.

How can I make sure my computer and printer are connected to the same wireless network?

If the printer is not on the same wireless network as the computer, then you will not be able to print wirelessly. The SSID of the printer must match the SSID of the computer, if the computer is already connected to the wireless network.

For Windows users

- 1 Obtain the SSID of the network that the computer is connected to:
 - a Type the IP address of your access point (wireless router) in the address field of your Web browser.

If you do not know the IP address of the access point:

 - 1 Click , or click **Start** and then click **Run**.
 - 2 In the Start Search or Run box, type `cmd`.
 - 3 Press **Enter**, or click **OK**.
 - 4 Type `ipconfig`, and then press **Enter**. Check the Wireless Network Connection section:
 - The “Default Gateway” entry is typically the access point.
 - The IP address appears as four sets of numbers separated by periods, such as 192.168.2.134.
 - b Type the user name and password of the router when prompted.
 - c Click **OK**.
 - d In the Wireless settings section, look for the SSID.
 - e Write down the SSID.

Note: Make sure you copy it exactly, including any capital letters.
- 2 Obtain the SSID of the network that the printer is connected to:
 - a From the printer, print a network setup page.
 - b In the Wireless section, look for **SSID**.

- 3 Compare the SSID of the computer and SSID of the printer.

If the SSIDs are the same, then the computer and the printer are connected to the same wireless network.

If the SSIDs are not the same, then run the utility again to set up the printer on the wireless network used by the computer.

For Macintosh users with an AirPort base station

In Mac OS X version 10.5 or later

- 1 From the Apple menu, navigate to:

System Preferences > Network > AirPort

The SSID of the network that the computer is connected to is displayed in the Network Name menu.

- 2 Write down the SSID.

In Mac OS X version 10.4 or earlier

- 1 From the Finder, navigate to:

Applications > Internet Connect > AirPort

The SSID of the network that the computer is connected to is displayed in the Network menu.

- 2 Write down the SSID.

For Macintosh users with an access point

- 1 Type the IP address of the access point in the address field of your Web browser and continue to step 2.

If you do not know the IP address of the access point, then do the following:

- a From the Apple menu, navigate to:

System Preferences > Network > AirPort

- b Click **Advanced** or **Configure**.

- c Click **TCP/IP**.

The Router entry is typically the access point.

- 2 Type your user name and password when prompted, and then click **OK**.

- 3 In the Wireless settings section, look for the SSID.

- 4 Write down the SSID, security type, and the WEP key/WPA passphrase (if shown).

Notes:

- Make sure you copy the network information down exactly, including any capital letters.
- Store the SSID and the WEP key or WPA passphrase in a safe place for future reference.

Can I use my printer on a USB and a network connection at the same time?

Yes, the printer supports a simultaneous USB and network connection. The printer can be configured in the following ways:

- Locally attached (connected to a computer using a USB cable)
- Wireless network
- Wireless network and locally attached simultaneously

What is a MAC address?

A Media Access Control (MAC) address is a 48-bit identifier associated with the hardware of network equipment. The MAC address may also be called the physical address because it is connected to the hardware of a device instead of its software. The MAC address is displayed as a hexadecimal number in this format: 01-23-45-67-89-AB.

While it is possible to change the MAC address of a network device, it is not common practice to do so. For this reason, MAC addresses are considered permanent. IP addresses are easily changed, so MAC addresses are a more reliable method of identifying a specific device on a network.

Routers with security capabilities may allow filtering of MAC addresses on networks. This allows a managed list of devices to access the network, identified by their MAC addresses, as well as prevent access from unwanted devices. If your network uses MAC address filtering, then be sure to add the MAC address of the printer to the list of allowed devices.

How do I find the MAC address?

Most network equipment has a unique hardware identification number to distinguish it from other devices on the network. This is called the *Media Access Control* (MAC) address.

When installing the printer on a network, make sure you select the printer with the correct MAC address.

The MAC address label is located inside the printer.

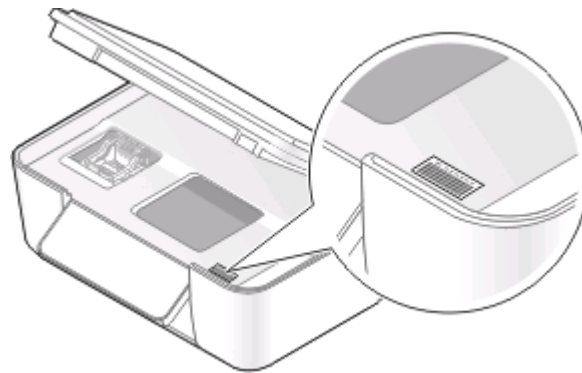

The MAC address of the internal print server is a series of letters and numbers. Other devices sometimes use a type of MAC address called *Universally Administered Address (UAA)*.



Note: A list of MAC addresses can be set on an access point (router) so that only devices with matching MAC addresses are allowed to operate on the network. This is called *MAC filtering*. If MAC filtering is enabled in your access point and you want to add a printer to your network, then the MAC address of the printer must be included in the MAC filter list.

What is an IP address?

An IP address is a unique number used by devices (such as a wireless printer, computer, or wireless access point) on an IP network to locate and communicate with each other. Devices on an IP network can communicate with each other only if they have unique and valid IP addresses. A unique IP address means no two devices on the same network have the same IP address.

An IP address is a group of four numbers separated by periods. An example of an IP address is 192.168.100.110.

What is TCP/IP?

Networks are able to function because computers, printers, and other devices are able to send data to each other, either through cables or by using wireless signals. This transfer of data is made possible by sets of data transmission rules called *protocols*. A protocol can be thought of as a language, and like a language, it has rules allowing participants to communicate with each other.

Different types of networks use different protocols, but *Transmission Control Protocol/Internet Protocol (TCP/IP)* is the most popular. TCP/IP is used to send data over the Internet as well as over most corporate and home networks.

Because computers do not understand words and instead rely upon numbers for communication, TCP/IP requires that every device on a network using TCP/IP to communicate must have an IP address. IP addresses are essentially unique computer names in a numeric format, used to transfer data around a network. IP addresses allow TCP/IP to confirm requests for and receipt of data by various devices on the network.

How do I locate IP addresses?

For Windows users

- 1 Click , or click **Start** and then click **Run**.
- 2 In the Start Search or Run box, type `cmd`.
- 3 Press **Enter**, or click **OK**.
- 4 Type `ipconfig`, and then press **Enter**.

The IP address appears as four sets of numbers separated by periods, such as 192.168.0.100.

For Macintosh users

- 1 From the Apple menu, navigate to:
About This Mac > More Info
- 2 From the Contents pane, choose **Network**.
- 3 If you are connected over a wireless network, then choose **AirPort** from the Active Services list.

Locating the printer IP address

- From the printer, print a network setup page.
In the TCP/IP section, look for **Address**.
- View the printer settings.
 - 1 From the printer control panel, navigate to:
 > **Network Setup > TCP/IP**
 - 2 Look for **IP Address**.

How are IP addresses assigned?

An IP address may be assigned automatically by the network using DHCP. Once the printer is set up on a computer, the computer sends all print jobs across the network to the printer using this address.

If the IP address is not automatically assigned, you will be asked during wireless setup to manually enter an address and other network information after selecting your printer from the available list.

What is a key index?

An access point (wireless router) can be configured with as many as four WEP keys. Only one key is used on the network at a time, however. The keys are numbered, and the number of a key is referred to as its key index. All devices on the wireless network must be configured to use the same key index when multiple WEP keys are configured on the access point.

Select the same key index on your printer as you are using on your access point.



Maintaining the printer

Maintaining ink cartridges

In addition to the following tasks that you can perform, your printer performs an automatic maintenance cycle every week if it is plugged into an electrical outlet. It will briefly come out of Power Saver mode or will temporarily power on if it is turned off.

Checking ink levels

Using the printer control panel

- 1 From the printer control panel, press .
- 2 Press the up or down arrow button to scroll to **Maintenance**, and then press .
- 3 Press  again to select **Check Ink Levels**.

Using the printer software

For Windows users

- 1 Click  or **Start**.
- 2 Click **All Programs** or **Programs**, and then select the printer program folder from the list.
- 3 Select **Printer Home**.
- 4 Choose your printer from the printer drop-down list.
- 5 From the Maintenance tab, click **Check ink levels**.

For Macintosh users



- 1 From the Finder desktop, double-click the printer program folder.
- 2 Select **Printer Utility** from the list.
- 3 Check the ink levels from the Maintenance tab.

Aligning the printhead

If the characters or lines on your printer image appear jagged or wavy, then you may need to align the printhead.

Using the printer control panel

- 1 Load plain paper.
- 2 From the printer control panel, press .

- 3 Press the up or down arrow button to scroll to **Maintenance**, and then press .
- 4 Press the up or down arrow button to scroll to **Align Printer**, and then press .
An alignment page prints.

Note: Do not remove the alignment page until printing is finished.

Using the printer software

For Windows users

- 1 Load plain paper.
- 2 Click  or **Start**.
- 3 Click **All Programs** or **Programs**, and then select the printer program folder from the list.
- 4 Select **Printer Home**.
- 5 Choose your printer from the printer drop-down list.
- 6 From the Maintenance tab, click **Align cartridges**.
- 7 Follow the instructions on the computer screen.

For Macintosh users

- 1 Load plain paper.
- 2 From the Finder desktop, double-click the printer program folder.
- 3 Select **Printer Utility** from the list.
- 4 From the Maintenance tab of the Printer Utility dialog, click **Print Alignment Page**.
- 5 Follow the instructions on the computer screen.

If you aligned the cartridges to improve print quality, then print your document again. If print quality has not improved, then clean the printhead nozzles.



Cleaning the printhead nozzles

Poor print quality is sometimes due to clogged printhead nozzles. Clean the printhead nozzles to improve the quality of your prints.

Notes:

- Cleaning the printhead nozzles uses ink, so clean them only when necessary.
- Deep cleaning uses more ink, so try the Clean Printhead option first to save ink.
- If the ink levels are too low, then you must replace the ink cartridges before you can clean the printhead nozzles.

Using the printer control panel

- 1 From the printer control panel, press .
- 2 Press the up or down arrow button to scroll to **Maintenance**, and then press .

- 3 Press the up or down arrow button to scroll to **Clean Printhead**, and then press **OK**.
A cleaning page prints.

Using the printer software

For Windows users

- 1 Click  or **Start**.
- 2 Click **All Programs** or **Programs**, and then select the printer program folder from the list.
- 3 Select **Printer Home**.
- 4 Select your printer from the printer drop-down list.
- 5 From the Maintenance tab, click **Clean Cartridges**.

For Macintosh users

- 1 From the Finder desktop, double-click the printer program folder.
- 2 Select **Printer Utility** from the list.
- 3 From the Maintenance tab, select **Clean Print Nozzles**.
A cleaning page prints.

Cleaning the exterior of the printer

- 1 Make sure that the printer is turned off and unplugged from the wall outlet.



CAUTION—SHOCK HAZARD: To avoid the risk of electric shock when cleaning the exterior of the printer, unplug the power cord from the wall outlet and disconnect all cables to the printer before proceeding.

- 2 Remove all paper from the printer.
- 3 Dampen a clean, lint-free cloth with water.

Warning—Potential Damage: Do not use household cleaners or detergents, as they may damage the finish of the printer.

- 4 Wipe only the outside of the printer, making sure to remove any ink residue that has accumulated on the paper exit tray.

Warning—Potential Damage: Using a damp cloth to clean the interior may cause damage to your printer.

- 5 Make sure the printer is dry before beginning a new print job.

Cleaning the scanner glass

- 1 Dampen a clean, lint-free cloth with water.
- 2 Gently wipe the scanner glass clean.

Note: Make sure all ink or corrective fluid on a document is dry before placing the document on the scanner glass.

Troubleshooting

Before you troubleshoot

Use this checklist to solve most printer problems:

- Make sure the power cord is plugged into the printer and into a working electrical outlet.
- Make sure the printer is not plugged into any surge protectors, uninterrupted power supplies, or extension cords.
- Make sure the printer is turned on.
- Make sure the printer is securely connected to the host computer, print server, or other network access point.
- Check the printer for error messages, and resolve any errors.
- Check for paper jam messages, and clear any jams.
- Check the ink cartridges, and install new cartridges if necessary.
- Use the Service Center to locate and solve the problem (Windows only).
- Turn the printer off, wait about 10 seconds, and then turn the printer back on.

Using the Service Center to solve printer problems

The Service Center provides step-by-step troubleshooting help and contains links to printer maintenance tasks and customer support.

To open the Service Center, use one of these methods:

Method 1	Method 2
If it appears on an error message dialog, click the For additional assistance, use the Service Center link.	<ol style="list-style-type: none">1 Click  or Start.2 Click All Programs or Programs, and then select the printer program folder from the list.3 Select Printer Home.4 From the Support tab, select Service Center.

If Troubleshooting does not solve your problem

Visit our Web site at support.dell.com to find the following:

- Live online technical support
- Contact numbers for telephone technical support

Setup troubleshooting

- "Incorrect language appears on the display" on page 87
- "Printhead errors" on page 87
- "Software did not install" on page 90
- "Print job does not print or is missing pages" on page 90

- “Printer is printing blank pages” on page 91
- “Printer is busy or does not respond” on page 92
- “Cannot delete documents from the print queue” on page 92
- “Cannot print through USB” on page 92

Incorrect language appears on the display





If the "Before you troubleshoot" checklist does not solve the problem, then try one or more of the following:



CHANGE THE LANGUAGE USING THE PRINTER MENUS

- 1 From the printer control panel, press .
- 2 Press the arrow buttons to scroll to **Default**s, and then press **OK**.
- 3 Press the arrow buttons to scroll to **Set Default**s, and then press **OK**.
- 4 Press the arrow buttons to scroll to **Use Factory**, and then press **OK**.
- 5 Complete the initial printer setup.

CHANGE THE LANGUAGE USING A BUTTON COMBINATION (IF YOU CANNOT READ THE CURRENT LANGUAGE)

- 1 Turn the printer off.

Note: If you have set the Power Saver timeout in the Setup menu, then press and hold  for three seconds to turn off the printer.
- 2 Press and hold down  and , and then press and release  to turn the printer on.

Note: Do not release  and  until **Language Selection** appears on the display, indicating that the printer has been reset.
- 3 Complete the initial printer setup.

Printhead errors

If the "Before you troubleshoot" checklist does not solve the problem, then try the following:

REMOVE AND REINSERT THE PRINthead

- 1 Open the printer and lift the latch.



- 2 Remove the printhead.



Warning—Potential Damage: Do not touch the printhead ink filter or the printhead nozzles.

- 3 Wipe the contacts using a clean, lint-free cloth.
 - On the printhead

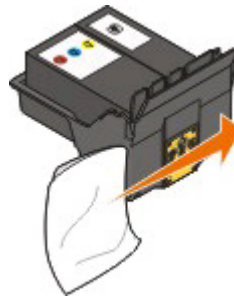

- On the printhead carrier

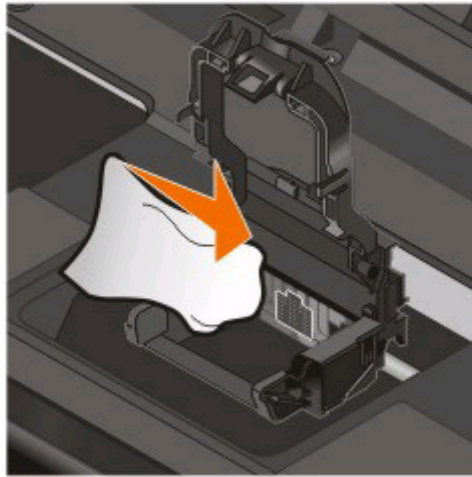

Warning—Potential Damage: Do not touch the printhead ink filter or the printhead nozzles.

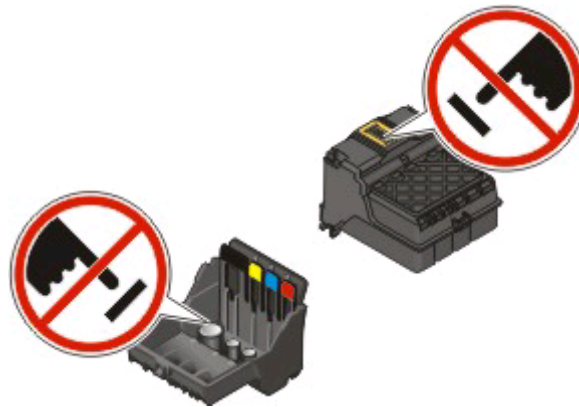

- 4 Reinsert the printhead, and then close the latch until it *clicks*.



- 5 Close the printer.

Note: If removing and reinserting the printhead does not resolve the error, then contact customer support.

Software did not install

If you encountered problems while installing, or if your printer does not appear in the list in the Printers folder or as a printer option when sending a print job, then try removing and reinstalling the software.

Before you reinstall the software, do the following:

MAKE SURE THAT YOUR COMPUTER MEETS THE MINIMUM SYSTEM REQUIREMENTS LISTED ON THE PRINTER BOX

TEMPORARILY DISABLE SECURITY PROGRAMS IN WINDOWS BEFORE INSTALLING THE SOFTWARE

CHECK THE USB CONNECTION

- 1 Check the USB cable for any obvious damage. If the cable is damaged, then use a new one.
- 2 Firmly plug the square end of the USB cable into the back of the printer.
- 3 Firmly plug the rectangular end of the USB cable into the USB port of the computer.

The USB port is marked with a  USB symbol.

Note: If you continue to have problems, then try another USB port on the computer. You may have connected to a defective port.

RECONNECT THE PRINTER POWER SUPPLY

- 1 Turn off the printer, and then unplug the power cord from the wall outlet.
- 2 Gently remove the power supply from the printer, and then reinsert it.
- 3 Plug the power cord into the wall outlet, and then turn on the printer.

Print job does not print or is missing pages

If the "Before you troubleshoot" checklist does not solve the problem, then try one or more of the following:

MAKE SURE THE INK CARTRIDGES ARE INSERTED CORRECTLY

- 1 Turn the printer on, and then open the printer.
- 2 Make sure the cartridges are inserted correctly.
The cartridges should *click* firmly into the matching color slot of the printhead.
- 3 Close the printer.

SELECT YOUR PRINTER FROM THE PRINT DIALOG BEFORE SENDING THE PRINT JOB

MAKE SURE THE PRINT JOB IS NOT PAUSED

MAKE SURE YOUR PRINTER IS SET AS THE DEFAULT PRINTER

RECONNECT THE PRINTER POWER SUPPLY

- 1 Turn off the printer, and then unplug the power cord from the wall outlet.
- 2 Gently remove the power supply from the printer, and then reinsert it.
- 3 Plug the power cord into the wall outlet, and then turn on the printer.

REMOVE AND RECONNECT THE USB CABLE CONNECTED TO YOUR PRINTER

CHECK THE USB CONNECTION

- 1 Check the USB cable for any obvious damage. If the cable is damaged, then use a new one.
- 2 Firmly plug the square end of the USB cable into the back of the printer.
- 3 Firmly plug the rectangular end of the USB cable into the USB port of the computer.

The USB port is marked with a  USB symbol.





Note: If you continue to have problems, then try another USB port on the computer. You may have connected to a defective port.

REMOVE AND REINSTALL THE PRINTER SOFTWARE

Printer is printing blank pages

Blank pages may be caused by improperly installed ink cartridges.

REINSTALL THE INK CARTRIDGES AND DEEP CLEAN AND ALIGN THE PRINTHEAD

- 1 Reinstall the ink cartridges. See “Replacing ink cartridges” on page 11 for more information.
If the cartridges do not seem to fit, make sure the printhead is properly seated, and then try installing the cartridges again.
- 2 Load plain paper.
- 3 From the printer control panel, press .
- 4 Press the arrow buttons to scroll to **Maintenance**, and then press .
- 5 Press the arrow buttons to scroll to **Deep Clean Printhead**, and then press .
- A cleaning page prints.
- 6 Press the arrow buttons to scroll to **Align Printer**, and then press .
- An alignment page prints.

Notes:

- Do not remove the alignment page until printing is finished.
- Do not perform consecutive deep cleans.
- Contact technical support if the problem persists after a deep clean.

Printer is busy or does not respond

If the "Before you troubleshoot" checklist does not solve the problem, then try one or more of the following:

MAKE SURE THE PRINTER IS NOT IN POWER SAVER MODE

If the power light is blinking on and off slowly, then the printer is in Power Saver mode. Press  to wake up the printer.

If the printer will not come out of Power Saver mode, then reset the power:

- 1 Unplug the power cord from the wall outlet, and then wait 10 seconds.
- 2 Insert the power cord into the wall outlet, and then turn on the printer.

If this problem persists, then check our Web site for updates for your printer software or firmware.

RECONNECT THE PRINTER POWER SUPPLY

- 1 Turn off the printer, and then unplug the power cord from the wall outlet.
- 2 Gently remove the power supply from the printer, and then reinsert it.
- 3 Plug the power cord into the wall outlet, and then turn on the printer.

Cannot delete documents from the print queue

If you have jobs stuck in the print queue and cannot delete them to get other jobs to print, then the computer and printer may not be communicating.

RESTART THE COMPUTER AND TRY AGAIN

Cannot print through USB

If the "Before you troubleshoot" checklist does not solve the problem, then try one or more of the following:

CHECK THE USB CONNECTION

- 1 Check the USB cable for any obvious damage. If the cable is damaged, then use a new one.
- 2 Firmly plug the square end of the USB cable into the back of the printer.
- 3 Firmly plug the rectangular end of the USB cable into the USB port of the computer.

The USB port is marked with a  USB symbol.

Note: If you continue to have problems, then try another USB port on the computer. You may have connected to a defective port.

MAKE SURE THE USB PORT IS ENABLED IN WINDOWS

- 1 Click , or click **Start** and then click **Run**.
- 2 In the Start Search or Run box, type `devmgmt.msc`.

- 3 Press **Enter**, or click **OK**.

The Device Manager opens.

- 4 Click the plus sign (+) beside Universal Serial Bus controllers.

If USB Host Controller and USB Root Hub are listed, then the USB port is enabled.

For more information, see the computer documentation.

REMOVE AND REINSTALL THE PRINTER SOFTWARE

Jams and misfeeds troubleshooting

- “Paper jam in the printer” on page 93
- “Paper jam in the paper support” on page 93
- “Paper jam in the duplex unit” on page 94
- “Paper or specialty media misfeeds” on page 95

Paper jam in the printer

Note: The parts inside the printer are sensitive. Avoid unnecessarily touching these parts while clearing jams.

- 1 Press  to turn off the printer.
- 2 Check the paper tray or lift the scanner unit to check for jammed paper.

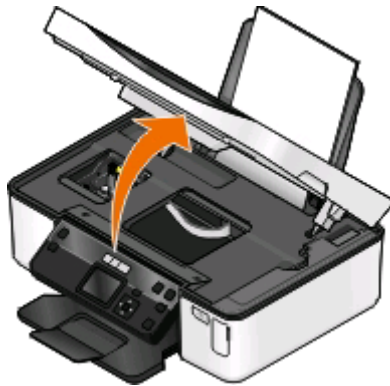

- 3 Firmly grasp the paper, and then gently pull it out.
Note: Be careful not to tear the paper while removing it.
- 4 Press  to turn the printer back on.

Paper jam in the paper support

Note: The parts inside the printer are sensitive. Avoid unnecessarily touching these parts while clearing jams.

- 1 Press  to turn off the printer.
- 2 Firmly grasp the paper, and then gently pull it out.
Note: Be careful not to tear the paper while removing it.

3 Press  to turn the printer back on.

Paper jam in the duplex unit

Note: The parts inside the printer are sensitive. Avoid unnecessarily touching these parts while clearing jams.

1 Push down the duplex latches and pull out the duplex unit.

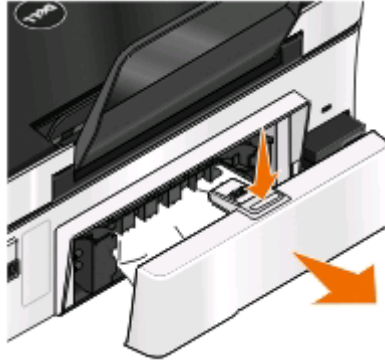

 **CAUTION—POTENTIAL INJURY:** The area behind the duplex cover has protruding ribs as part of the paper path. To avoid injury, use caution when accessing this area for clearing a paper jam.

2 Firmly grasp the paper, and then gently pull it out.

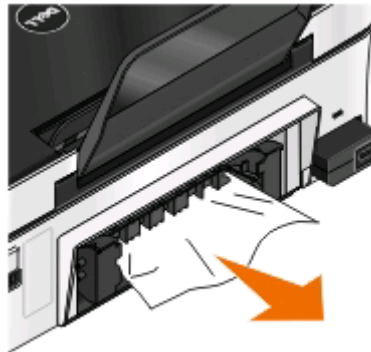

Note: Be careful not to tear the paper while removing it.

3 Reinsert the duplex unit.

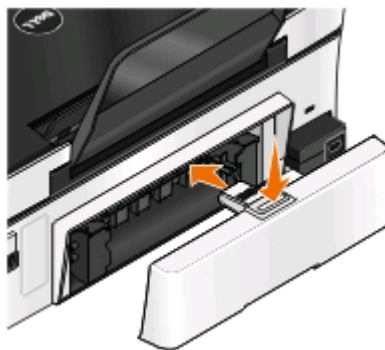

4 Touch **DONE** or press **OK**, depending on your printer model.

5 From your computer, resume the print job.

Paper or specialty media misfeeds

These are possible solutions if paper or specialty media misfeeds or skews, or if multiple sheets feed or stick together. Try one or more of the following:

CHECK PAPER CONDITION

Use only new, unwrinkled paper.

CHECK PAPER LOADING

- Load a smaller amount of paper into the printer.
- Load paper with the print side faceup. (If you are not sure which side is the printable side, see the instructions that came with the paper.)
- Check the loading instructions for your paper or specialty media.

REMOVE EACH PAGE AS IT IS PRINTED

ADJUST THE PAPER GUIDES TO FIT THE LOADED PAPER

Print troubleshooting

- "Poor quality at the edges of the page" on page 95
- "Streaks or lines on printed image" on page 96
- "Print speed is slow" on page 97
- "Computer slows down when printing" on page 97

Poor quality at the edges of the page

If the "Before you troubleshoot" checklist does not solve the problem, then try one or more of the following:

CHECK MINIMUM PRINT SETTINGS

Unless you are using the borderless feature, use these minimum print margin settings:

- Left and right margins:
 - 6.35 mm (0.25 in.) for letter-size paper
 - 3.37 mm (0.133 in.) for all paper sizes except letter
- Top margin: 1.7 mm (0.067 in.)
- Bottom margin: 12.7 mm (0.5 in.)

SELECT THE BORDERLESS PRINT FEATURE

For Windows users

- 1 With a document or photo open, click **File > Print**.
- 2 Click **Properties, Preferences, Options, or Setup**.
- 3 From the Paper Options area of the Print Setup tab, select **Borderless**.

For Macintosh users

- 1 With a photo open, choose **File > Page Setup**.

If there is no Page Setup item on the File menu, then go to step 2. Otherwise, specify your print settings:

- a From the Settings pop-up menu, choose **Page Attributes**.
 - b From the "Format for" pop-up menu, choose your printer.
 - c From the Paper Size pop-up menu, choose a paper size that has "(Borderless)" in its name.
For example, if you loaded a 4 x 6 photo card, then choose **US 4 x 6 in (Borderless)**.
 - d Select an orientation, and then click **OK**.
- 2 From the menu bar, choose **File > Print**.
If you have already specified the printer, paper size, and orientation in step 1, then you may have to choose your printer again from the Printer pop-up menu before going to step 3. Otherwise, set them:
 - a From the Printer pop-up menu, choose your printer.
 - b From the Paper Size pop-up menu, choose a paper size that has "(Borderless)" in its name.
For example, if you loaded a 4 x 6 photo card, then choose **US 4 x 6 in (Borderless)**.
 - c Select an orientation.
 - 3 If necessary, click **Advanced**.
 - 4 From the print options pop-up menu, choose **Print Settings** or **Quality & Media**.
 - From the Paper Type pop-up menu, choose a paper type.
 - From the Print Quality pop-up menu, choose **Photo** or **Best**.
 - 5 Click **Print**.

Streaks or lines on printed image

If the "Before you troubleshoot" checklist does not solve the problem, then try one or more of the following:

CHECK THE INK LEVELS

Replace low or empty ink cartridges.

SELECT A HIGHER PRINT QUALITY FROM THE PRINTER SOFTWARE

MAKE SURE THE INK CARTRIDGES ARE PROPERLY INSTALLED

ALIGN THE PRINTHEAD

CLEAN OR DEEP CLEAN THE PRINTHEAD NOZZLES

Note: If these solutions do not remove the streaks or lines on the printed image, then contact technical support.

Print speed is slow

If the "Before you troubleshoot" checklist does not solve the problem, then try one or more of the following:

MAXIMIZE COMPUTER PROCESSING SPEED

- Close all applications not in use.
- Minimize the number and size of graphics and images in the document.
- Remove as many unused fonts as possible from your system.

ADD MEMORY

Consider purchasing more RAM.

SELECT A LOWER PRINT QUALITY FROM THE PRINTER SOFTWARE

MANUALLY SELECT A PAPER TYPE THAT MATCHES THE TYPE OF PAPER YOU ARE USING

REMOVE AND REINSTALL THE PRINTER SOFTWARE

Computer slows down when printing

These are possible solutions. Try one of the following:

IF YOU ARE USING A USB CONNECTION, THEN TRY A DIFFERENT USB CABLE

IF YOU ARE ON A NETWORK, THEN RESET THE POWER OF THE ACCESS POINT (ROUTER)

- 1 Unplug the power cord from the access point.
- 2 Wait ten seconds, and then insert the power cord.

Copy and scan troubleshooting

- "Copier or scanner does not respond" on page 98
- "Scanner unit does not close" on page 98
- "Poor copy or scanned image quality" on page 98
- "Partial copies or scans of documents or photos" on page 98
- "Scan was not successful" on page 99
- "Scanning takes too long or freezes the computer" on page 99
- "Cannot scan to a computer over a network" on page 99

Copier or scanner does not respond

If the "Before you troubleshoot" checklist does not solve the problem, then try one or more of the following:

SET YOUR PRINTER AS THE DEFAULT PRINTER

REMOVE AND REINSTALL THE PRINTER SOFTWARE

Scanner unit does not close

- 1 Lift the scanner unit.
- 2 Remove any obstruction keeping the scanner unit open.
- 3 Lower the scanner unit.

Poor copy or scanned image quality

If the "Before you troubleshoot" checklist does not solve the problem, then try one or more of the following:

CLEAN THE SCANNER GLASS

ADJUST THE SCAN QUALITY FROM THE PRINTER SOFTWARE

REVIEW THE TIPS FOR COPYING, SCANNING, AND IMPROVING PRINT QUALITY

USE A CLEARER VERSION OF THE ORIGINAL DOCUMENT OR IMAGE

MAKE SURE THE DOCUMENT OR PHOTO IS LOADED FACEDOWN ON THE SCANNER GLASS AND IN THE CORRECT CORNER

Partial copies or scans of documents or photos

If the "Before you troubleshoot" checklist does not solve the problem, then try one or more of the following:

MAKE SURE THE DOCUMENT OR PHOTO IS LOADED FACEDOWN ON THE SCANNER GLASS AND IN THE CORRECT CORNER

SELECT A PAPER SIZE FROM THE PRINTER SOFTWARE THAT MATCHES THE LOADED PAPER

MAKE SURE THE ORIGINAL SIZE SETTING MATCHES THE SIZE OF THE DOCUMENT YOU ARE SCANNING

Scan was not successful

If the "Before you troubleshoot" checklist does not solve the problem, then try one or more of the following:

CHECK THE USB CONNECTION

- 1 Check the USB cable for any obvious damage. If the cable is damaged, then use a new one.
- 2 Firmly plug the square end of the USB cable into the back of the printer.
- 3 Firmly plug the rectangular end of the USB cable into the USB port of the computer.

The USB port is marked with a  USB symbol.

Note: If you continue to have problems, then try another USB port on the computer. You may have connected to a defective port.

RESTART THE COMPUTER

Scanning takes too long or freezes the computer

If the "Before you troubleshoot" checklist does not solve the problem, then try one or more of the following:

CLOSE OTHER SOFTWARE PROGRAMS THAT ARE NOT BEING USED

USE A LOWER SCANNING RESOLUTION

Cannot scan to a computer over a network

If the "Before you troubleshoot" checklist does not solve the problem, then try one or more of the following:

MAKE SURE THE PRINTER AND THE DESTINATION COMPUTER ARE CONNECTED TO THE SAME NETWORK

MAKE SURE THE PRINTER SOFTWARE IS INSTALLED ON THE DESTINATION COMPUTER

Memory card troubleshooting

- "Memory card troubleshooting checklist" on page 100
- "Nothing happens when a memory card is inserted" on page 100
- "Cannot print documents from a memory card or flash drive" on page 100
- "Photos do not transfer from a memory card across a wireless network" on page 101

Memory card troubleshooting checklist

Before you troubleshoot, use the following checklist to solve most memory card problems:

- Make sure that the memory card you are using can be used in the printer.
- Make sure the memory card is not damaged.
- Make sure memory card contains supported file types.

Nothing happens when a memory card is inserted

If the "Memory card troubleshooting checklist" does not solve the problem, then try one or more of the following:

REINSERT THE MEMORY CARD

The memory card may have been inserted too slowly. Remove and then reinsert the memory card quickly.

CHECK THE USB CONNECTION

- 1 Check the USB cable for any obvious damage. If the cable is damaged, then use a new one.
- 2 Firmly plug the square end of the USB cable into the back of the printer.
- 3 Firmly plug the rectangular end of the USB cable into the USB port of the computer.

The USB port is marked with a  USB symbol.

Note: If you continue to have problems, then try another USB port on the computer. You may have connected to a defective port.

CHECK THE NETWORK CONNECTION

If the printer and computer are connected over a network, then make sure that the correct host and device are communicating. Select the printer from the computer or the computer from the printer.

Cannot print documents from a memory card or flash drive

If the "Memory card troubleshooting checklist" does not solve the problem, then try the following:

CHECK THE USB CONNECTION

- 1 Check the USB cable for any obvious damage. If the cable is damaged, then use a new one.
- 2 Firmly plug the square end of the USB cable into the back of the printer.
- 3 Firmly plug the rectangular end of the USB cable into the USB port of the computer.

The USB port is marked with a  USB symbol.

Note: If you continue to have problems, then try another USB port on the computer. You may have connected to a defective port.

CHECK THE NETWORK CONNECTION

If the printer and computer are connected over a network, then make sure that the correct host and device are communicating. Select the printer from the computer or the computer from the printer.

Photos do not transfer from a memory card across a wireless network

If the "Memory card troubleshooting checklist" does not solve the problem, then try one or more of the following:

MAKE SURE THAT BOTH THE PRINTER AND THE DESTINATION COMPUTER ARE TURNED ON AND READY

SELECT THE CORRECT COMPUTER NAME FROM THE LIST ON THE PRINTER

MAKE SURE YOUR WIRELESS NETWORK IS CONNECTED AND ACTIVE

If your wireless connection is down, then use a USB cable to connect your printer to your computer.

Wireless troubleshooting

- "Wireless troubleshooting checklist" on page 101
- "Resetting the wireless settings to factory defaults" on page 102
- "Cannot print over wireless network" on page 102
- "The Continue button is unavailable" on page 106
- "Cannot print and there is a firewall on the computer" on page 107
- "Wi-Fi indicator light is not lit" on page 107
- "Wi-Fi indicator light is green but the printer does not print (Windows only)" on page 108
- "Wi-Fi indicator light is still orange" on page 109
- "Wi-Fi indicator light is blinking orange during installation" on page 110
- "Wireless print server not installed" on page 114
- "'Communication not available' message appears when printing wirelessly" on page 114
- "Communication with printer lost when connected to Virtual Private Network (VPN)" on page 116
- "Resolving intermittent wireless communications issues" on page 116

Wireless troubleshooting checklist

Before beginning to troubleshoot the wireless printer, verify the following:

- The printer, the computer, and the wireless access point are all plugged in and turned on.
- The wireless network is working properly.
Try accessing other computers on your wireless network.
If your network has Internet access, try connecting to the Internet over a wireless connection.
- Your SSID is correct.
Print a network setup page to verify the SSID the printer is using.
If you are not sure if your SSID is correct, then run the wireless setup again.

- Your WEP key or WPA passphrase is correct (if your network is secure).

Log into the wireless access point (wireless router) and check the security settings.

A security key is like a password. All devices on the same wireless network using WEP, WPA, or WPA2 share the same security key.

If you are not sure if your security information is correct, run the wireless setup again.

- The printer and the computer are within the range of the wireless network.





For most networks, the printer and the computer should be within 100 feet (30 meters) of the wireless access point (wireless router).

- The Wi-Fi indicator light is lit and is solid green.
- The printer driver is installed on the computer from which you are performing a task.
- The correct printer port is selected.
- The computer and printer are both connected to the same wireless network.
- The printer is located away from obstacles or electronic devices that could interfere with the wireless signal.

Make sure the printer and wireless access point are not separated by poles, walls, or support columns containing metal or concrete.

Many devices can interfere with the wireless signal, including baby monitors, motors, cordless phones, security system cameras, other wireless networks, and some Bluetooth devices.

Resetting the wireless settings to factory defaults

- 1 From the printer control panel, press .
- 2 Press the arrow buttons to scroll to **Network Setup**, and then press .
- 3 Press the arrow buttons to scroll to **Reset Network Adapter to Factory Defaults**, and then press .
- 4 Press the arrow buttons to scroll to **Yes**, and then press .

The printer wireless settings are reset to factory default settings. To verify, print a network setup page.

Cannot print over wireless network

If you encountered problems while installing, or if your printer does not appear in the printers folder or as a printer option when sending a print job, then you can try uninstalling and reinstalling the software.

Before you reinstall the software, check the troubleshooting checklist, and then do the following:

TURN THE ACCESS POINT (WIRELESS ROUTER) OFF AND THEN BACK ON

Wait one minute for the printer and computer to reestablish the connection. This can sometimes refresh network connections and resolve connectivity issues.

DISCONNECT FROM VPN SESSION

When you are connected to another network through a VPN connection, you will not be able to access the printer over your wireless network. End your VPN session and try printing again.

MAKE SURE DEMO MODE IS TURNED OFF

Certain printer features are not available when Demo Mode is turned on.

From the printer control panel, navigate to:

 > **Demo Mode** > **Off** > save the setting

CHECK YOUR WEP KEY OR WPA PASSPHRASE

If your access point is using WEP security, then the WEP key should be:

- Exactly 10 or 26 hexadecimal characters. Hexadecimal characters are A–F, a–f, and 0–9.
or
- Exactly 5 or 13 ASCII characters. ASCII characters are letters, numbers, and symbols found on a keyboard. ASCII characters in a WEP key are case-sensitive.

If your access point is using WPA or WPA2 security, then the WPA passphrase should be:

- Exactly 64 hexadecimal characters. Hexadecimal characters are A–F, a–f, and 0–9.
or
- From 8 to 63 ASCII characters. ASCII characters are letters, numbers, and symbols found on a keyboard. ASCII characters in a WPA passphrase are case-sensitive.

Note: If you do not know this information, then see the documentation that came with the wireless network, or contact the person who set up your wireless network.

CHECK IF YOUR ACCESS POINT HAS AN ASSOCIATION/REGISTRATION BUTTON

Wireless broadband boxes in Europe, the Middle East, and Africa such as LiveBox, AliceBox, N9UF Box, FreeBox, or Club Internet may require you to press an association/registration button when adding the printer to your wireless network.

If you are using one of these boxes and need more information, then see the documentation that came with your box, or contact your Internet Service Provider (ISP).

MOVE YOUR ACCESS POINT AWAY FROM OTHER ELECTRONIC DEVICES

There may be temporary interference from electronic devices such as microwave ovens or other appliances, cordless phones, baby monitors, and security system cameras. Make sure your access point is not positioned too closely to these devices.

MOVE THE COMPUTER AND/OR PRINTER CLOSER TO THE ACCESS POINT

The range of your wireless network depends on many factors, including the abilities of your access point and network adapters. If you are having trouble printing, then try placing the computer and printer no more than 100 feet apart.

CHECK THE WIRELESS SIGNAL QUALITY

Print a network setup page and check the signal quality. If the signal quality is listed as good or excellent, then another factor is causing the problem.

CHECK YOUR ADVANCED SECURITY SETTINGS

- If you are using MAC (Media Access Control) address filtering to limit access to your wireless network, then you must add the printer MAC address to the list of addresses allowed to connect to the access point.
- If you set the access point to issue a limited number of IP addresses, then you must change this so that the printer can be added.

Note: If you do not know how to make these changes, then see the documentation that came with the access point, or contact the person who set up your wireless network.

MAKE SURE YOUR COMPUTER IS CONNECTED TO YOUR ACCESS POINT

- See if you have access to the Internet by opening your Web browser and accessing any site.
- If there are other computers or resources on your wireless network, then check to see if you can access them from your computer.

MAKE SURE YOUR COMPUTER AND PRINTER ARE CONNECTED TO THE SAME WIRELESS NETWORK

If the printer is not on the same wireless network as the computer, then you will not be able to print wirelessly. The SSID of the printer must match the SSID of the computer, if the computer is already connected to the wireless network.

For Windows users

- 1 Obtain the SSID of the network that the computer is connected to.
 - a Type the IP address of your access point into the address field of your Web browser.

If you do not know the IP address of the access point:

 - 1 Click , or click **Start** and then click **Run**.
 - 2 In the Start Search or Run box, type **cmd**.
 - 3 Press **Enter** or click **OK**.
 - 4 Type **ipconfig**, and then press **Enter**. Check the Wireless Network Connection section:
 - The "Default Gateway" entry is typically the access point .
 - The IP address appears as four sets of numbers separated by periods, such as 192.168.2.134.
 - b Type the user name and password of the access point when prompted.
 - c Click **OK**.
 - d In the Wireless settings section, look for the SSID.
 - e Write down the SSID.

Note: Make sure you copy it exactly, including any capital letters.
- 2 Obtain the SSID of the network that the printer is connected to:
 - a From the printer, print a network setup page.
 - b In the Wireless section, look for **SSID**.
- 3 Compare the SSID of the computer and SSID of the printer.

If the SSIDs are the same, then the computer and the printer are connected to the same wireless network.

If the SSIDs are not the same, then run the utility again to set up the printer on the wireless network used by the computer.

For Macintosh users with an AirPort base station

In Mac OS X version 10.5 or later

- 1 From the Apple menu, navigate to:

System Preferences > Network > AirPort

The SSID of the network that the computer is connected to is displayed in the Network Name menu.

- 2 Write down the SSID.

In Mac OS X version 10.4

- 1 From the Finder, navigate to:

Applications > Internet Connect > AirPort

The SSID of the network that the computer is connected to is displayed in the Network menu.

- 2 Write down the SSID.

For Macintosh users with an access point

- 1 Type the IP address of the access point in the address field of your Web browser, and then continue to step 2.

If you do not know the IP address of the access point, then do the following:

- a From the Apple menu, navigate to:
System Preferences > Network > AirPort
- b Click **Advanced** or **Configure**.
- c Click **TCP/IP**.

The Router entry is typically the access point.

- 2 Type your user name and password when prompted, and then click **OK**.
- 3 In the Wireless settings section, look for the SSID.
- 4 Write down the SSID, security type, and the WEP key/WPA passphrase (if shown).

Notes:

- Make sure you copy the network information down exactly, including any capital letters.
- Store the SSID and the WEP key or WPA passphrase in a safe place for future reference.

MAKE SURE YOUR OS IS COMPATIBLE WITH WIRELESS PRINTING THROUGH AIRPORT (MACINTOSH ONLY)

The printer supports wireless printing only through AirPort base stations for Mac OS X version 10.5 or later.

The Continue button is unavailable

Try the following solutions in the order they appear until the Continue button becomes active and can be clicked:

CHECK IF THE **USB** CABLE IS SECURELY PLUGGED INTO THE **USB** PORTS ON BOTH THE COMPUTER AND THE PRINTER

USB ports are marked with the  symbol.

MAKE SURE THAT THE PRINTER IS PLUGGED IN AND TURNED ON

Check to see if the  button is lit. If you have just turned on the printer, then you might need to disconnect the USB cable and reconnect it.

MAKE SURE THAT THE **USB** PORT ON THE COMPUTER IS WORKING

Test the USB port by connecting other devices to it. If you can successfully use other devices from the port, then the port is working.

If the USB port on the computer is not working, then try using the other USB ports on the computer.

MAKE SURE THAT THE **USB** CABLE IS WORKING

Try using a different USB cable. If you are using a cable longer than 10 feet, then try using a shorter cable.

MAKE SURE THAT YOU ARE USING THE CORRECT **CD** FOR YOUR PRINTER MODEL

Compare the printer model on the CD to the printer model on the printer. The numbers should either match exactly or be within the same series.

If you have any doubts, look for an updated version of the printer software on our Web site. For more information, see "Installing the printer software" in the *User's Guide*. You can access the *User's Guide* from the link at the bottom of the installation screen.

RECONNECT THE POWER SUPPLY

- 1 Turn off the printer.
- 2 Unplug the power cord from the power outlet.
- 3 Remove the power supply from the back of the printer and then plug it back in.
- 4 Plug the power cord back into the power outlet.
- 5 Turn on the printer, and then resume the installation on your computer.

TRY RUNNING THE INSTALLER AGAIN

- 1 Close the installer.
- 2 Remove the CD, and then restart the computer.
- 3 Insert the CD and then run the installer again.

Notes:

- When you get to the **Software Already Installed** screen, make sure you select **Install a printer**.
- If you have already set up your printer, select **Additional Computer** when you get to the **Setting up a new printer?** screen to skip the hardware setup wizard.

CHECK THAT YOUR COMPUTER IS ABLE TO ACKNOWLEDGE USB ACTIVITY ON THE USB PORT

Open the Device Manager to check if it has activity whenever a USB device is connected to a USB port:

- 1 Click , or click **Start** and then click **Run**.
- 2 In the Start Search or Run box, type `devmgmt.msc`.
- 3 Press **Enter**, or click **OK**.
The Device Manager opens.
- 4 Watch the Device Manager window while connecting a USB cable or another device to the USB port. The window refreshes when Device Manager recognizes the USB connection.
 - If there is activity on Device Manager but none of the previous solutions worked, call Customer Support.
 - If there is no activity on Device Manager, there may be a problem with your computer and its USB support. The computer must recognize the USB connection in order for installation to work.

Cannot print and there is a firewall on the computer

Third-party (non-Microsoft) firewalls can interfere with wireless printing. If the printer and computer are configured correctly, and the wireless network is working, but the printer will not print wirelessly, then a firewall could be the problem. If there is a firewall (other than the Windows firewall) on the computer, try one or more of the following:

- Update the firewall using the most recent update available from the manufacturer. Refer to the documentation that came with your firewall for instructions on how to do this.
- If programs request firewall access when you install the printer or try to print, make sure you allow those programs to run.
- Temporarily disable the firewall and install the wireless printer on the computer. Re-enable the firewall when you have completed the wireless installation.

Wi-Fi indicator light is not lit

CHECK POWER

If the Wi-Fi indicator light is off, make sure the  light is on. If the  light is not on, check the following:

- Make sure the printer is plugged in and turned on.
- Make sure the printer is plugged into a working outlet.
- If the printer is plugged into a power strip, make sure it is turned on and working.

Wi-Fi indicator light is green but the printer does not print (Windows only)

If you have completed the configuration for wireless printing and all of the settings appear to be correct, but the printer does not print, then try one or more of the following:

ALLOW THE WIRELESS INSTALLATION TO COMPLETE

Do not attempt to print, remove the installation CD, or detach the installation cable until you see the Wireless Setup Successful screen.

ENABLE THE PRINTER

Confirm that the printer is enabled:

- 1 Click , or click **Start** and then click **Run**.
- 2 In the Start Search or Run box, type `control printers`.
- 3 Press **Enter**, or click **OK**.
The printer folder opens.
- 4 Right-click the new printer; from the menu, select **Use Printer Online**.
- 5 Close the Printers or Printers and Faxes window and try printing again.

SELECT THE WIRELESS PRINTER

You may need to select the wireless printer from your computer to use the printer wirelessly.

- 1 Click , or click **Start** and then click **Run**.
- 2 In the Start Search or Run box, type `control printers`.
- 3 Press **Enter**, or click **OK**.
The printer folder opens.
- 4 Right-click the printer in the folder with the matching name and model number followed by "(Network)."
- 5 Select **Use Printer Online** from the menu.
- 6 Close the Printers or Printers and Faxes window and try printing again.

SELECT THE WIRELESS PORT

If you have previously set up your printer as a locally attached printer, then you may need to select the wireless printer to use the printer wirelessly.

- 1 Click , or click **Start** and then click **Run**.
- 2 In the Start Search or Run box, type `control printers`.
- 3 Press **Enter**, or click **OK**.
The printer folder opens.
- 4 Right-click the printer, and then select **Properties** from the menu.

- 5 Click the **Ports** tab.
- 6 Locate the selected port. The selected port has a check beside it in the Port column.
- 7 If the Description column of the selected port indicates that it is a USB port, scroll through the list and select the port with Printer Port in the Description column. Check the printer model in the Printer column to make sure you select the right printer port.
- 8 Click **OK**, and then try to print again.

Wi-Fi indicator light is still orange

When the Wi-Fi indicator light is orange, it may indicate that the printer is:

- Not configured in infrastructure mode
- Waiting to make an ad hoc connection to another wireless device
- Not connected to a wireless network

The printer may be unable to join the network because of interference, its distance from the wireless access point (wireless router), or until its settings are changed.

These are possible solutions. Try one or more of the following:

CHECK NETWORK NAME

Make sure your network does not have the same name as another network near you. For example, if you and your neighbor both use a manufacturer's default network name, your printer could be connecting to your neighbor's network.

If you are not using a unique network name, consult the documentation for your wireless access point (wireless router) to learn how to set a network name.

If you set a new network name, you must reset the printer and computer SSID to the same network name.

CHECK SECURITY KEYS

If you are using WEP security

A valid WEP key is:

- Exactly 10 or 26 hexadecimal characters. Hexadecimal characters are A–F, a–f, and 0–9.
- or*
- Exactly 5 or 13 ASCII characters. ASCII characters are letters, numbers, and symbols found on a keyboard.

If you are using WPA security

A valid WPA passphrase is:

- From 8 to 63 ASCII characters. ASCII characters in a WPA passphrase are case-sensitive.
- or*
- Exactly 64 hexadecimal characters. Hexadecimal characters are A–F, a–f, and 0–9.

If your wireless network is not using security, then you will not have a security key. Using a wireless network with no security is not recommended because it can allow intruders to use your network resources without your consent.

MOVE THE COMPUTER AND/OR PRINTER CLOSER TO THE WIRELESS ACCESS POINT (WIRELESS ROUTER)

The possible distance between devices in 802.11b or 802.11g networks is 300 feet, while the wireless network range potentially doubles in 802.11n networks. The range of your wireless network depends on many factors, including the abilities of your router and network adapters. If you are having trouble printing, try placing the computer and printer no more than 100 feet apart.

You can find the strength of the network signal on the printer network setup page.

CHECK MAC ADDRESS

If your network uses MAC address filtering, make sure that you include the MAC address of the printer in the MAC address filter list. This will allow the printer to operate on the network.

Wi-Fi indicator light is blinking orange during installation

When the Wi-Fi indicator light is blinking orange, it indicates that the printer has been set up for wireless networking but cannot connect to the network for which it has been configured. The printer may be unable to join the network because of interference, its distance from the wireless access point (wireless router), or until its settings are changed.

Try one or more of the following:

MAKE SURE THE ACCESS POINT IS ON

Check the access point, and if necessary, turn it on.

MOVE YOUR ACCESS POINT TO MINIMIZE INTERFERENCE

There may be temporary interference from other devices such as microwave ovens or other appliances, cordless phones, baby monitors, and security system cameras. Make sure your access point is not positioned too closely to these devices.

MOVE THE COMPUTER AND/OR PRINTER CLOSER TO THE ACCESS POINT

The possible distance between devices in 802.11b or 802.11g networks is 300 feet, while the wireless network range potentially doubles in 802.11n networks. The range of your wireless network depends on many factors, including the abilities of your access point and wireless network adapters. If you are having trouble printing, then try placing the computer and printer no more than 100 feet apart.

You can find the signal strength of the network on the network setup page.

CHECK YOUR WEP KEY OR WPA PASSPHRASE

If your access point is using WEP security, then the WEP key should be:

- Exactly 10 or 26 hexadecimal characters. Hexadecimal characters are A–F, a–f, and 0–9.
- or*
- Exactly 5 or 13 ASCII characters. ASCII characters are letters, numbers, and symbols found on a keyboard.

If your access point is using WPA or WPA2 security, then the WPA passphrase should be:

- Exactly 64 hexadecimal characters. Hexadecimal characters are A–F, a–f, and 0–9.
- or*
- From 8 to 63 ASCII characters. ASCII characters are letters, numbers, and symbols found on a keyboard. ASCII characters in a WPA passphrase are case-sensitive.



Note: If you do not know this information, then see the documentation that came with the wireless network, or contact the person who set up your wireless network.

CHECK THE MAC ADDRESS

If your network uses MAC address filtering, then make sure that you include the MAC address of the printer in the MAC address filter list. This will allow the printer to operate on the network. For more information, see “How do I find the MAC address?” on page 80.

PING THE ACCESS POINT TO MAKE SURE THE NETWORK IS WORKING

For Windows users

- 1 Obtain the IP address of the access point.
 - a Click , or click **Start** and then click **Run**.
 - b In the Start Search or Run box, type `cmd`.
 - c Press **Enter**, or click **OK**.
 - d Type `ipconfig`, and then press **Enter**.
 - The “Default Gateway” entry is typically the access point.
 - The IP address appears as four sets of numbers separated by periods, such as 192.168.2.134.
- 2 Ping the access point:
 - a Click , or click **Start** and then click **Run**.
 - b In the Start Search or Run box, type `cmd`.
 - c Press **Enter**, or click **OK**.
 - d Type `ping` followed by a space and the IP address of the access point. For example:
`ping 192.168.1.100`
 - e Press **Enter**.
- 3 Check to see whether the access point responds:
 - If the access point responds, then you will see several lines appear that start with “Reply from.” It is possible that the printer did not connect to the wireless network. Turn off and then restart the printer to try to connect again.
 - If the access point does not respond, then “Request timed out.” appears.

Try the following:

- a Click , or click **Start** and then click **Run**.
- b In the Start Search or Run box, type `ncpa.cp1`, and then press **Enter**.
- c Press **Enter** or click **OK**.
- d Select the appropriate connection from the ones shown.
- e Right-click the connection, and then click **Repair** or **Diagnose**.

For Macintosh users

- 1 Make sure AirPort is turned on:

From the Apple menu, navigate to:

System Preferences > Network

The AirPort status indicator should be green.

Notes:

- Yellow means the port is active but not connected.
- Red means the port has not been configured.

- 2 Obtain the IP address of the access point:

a From the Apple menu, navigate to:

About This Mac > More Info

b From the Contents pane, choose **Network**.

c From the Active Services list, choose **AirPort**.

The bottom pane lists the details of the AirPort connection.

d Write down the Router entry.

The Router entry is typically the access point.

- 3 Ping the access point:

a From the Finder, navigate to:

Utilities > Network Utility > Ping tab

b In the network address field, type the IP address of the access point. For example:

`10.168.1.101`

c Click **Ping**.

- 4 If the access point responds, then you will see several lines that display the number of bytes received from the access point. This means that your computer is connected to the access point.

If the access point does not respond, then nothing is displayed. You can use Network Diagnostics to help resolve the problem.

MAKE SURE YOUR COMPUTER CAN COMMUNICATE WITH THE PRINTER

For Windows users

- 1 Obtain the printer IP address.

a From the printer, print a network setup page.

For more information, see the *User's Guide*.

b In the TCP/IP section, look for **Address**.

- 2 Click , or click **Start** and then click **Run**.

- 3 In the Start Search or Run box, type `cmd`.

- 4 Press **Enter**, or click **OK**.

- 5 Type `ping` followed by a space and the IP address of the printer. For example:

`ping 192.168.1.100`

- 6 Press **Enter**.
- 7 If the printer responds, then you will see several lines that display the number of bytes received from the printer. This ensures that your computer is communicating with your printer.
If the printer does not respond, then "Request timed out." appears.
 - Your computer might not be connected to the network.
 - You may need to change the settings of your printer. Run the Wireless Setup Utility again.

For Macintosh users

- 1 Obtain the printer IP address.
 - a From the printer, print a network setup page.
For more information, see the *User's Guide*.
 - b In the TCP/IP section, look for **Address**.
- 2 From the Finder, navigate to:
Utilities > Network Utility > Ping tab
- 3 Type the IP address of the printer in the network address field. For example:
10.168.1.101
- 4 Click **Ping**.
- 5 If the printer responds, then you will see several lines that display the number of bytes received from the printer. This means that your computer is communicating with your printer.
If the printer does not respond, then nothing is displayed.
 - Your computer might not be connected to the network. You can use Network Diagnostics to help resolve the problem.
 - You may need to change the settings of your printer. Run the Wireless Setup Assistant again.

CONFIGURE THE PRINTER FOR WIRELESS ACCESS AGAIN

If your wireless settings have changed, then you must run the printer wireless setup again. The WEP or WPA key, channel, or other network settings may have been manually changed; or the access point may have been reset to factory defaults.

Running the wireless setup again can also resolve issues due to wireless configuration errors.

Notes:

- If you change network settings, then change them on all the network devices before changing them for the access point.
- If you have already changed the wireless network settings on your access point, then you must change the settings on all the other network devices before you can see them on the network.

For Windows users

- 1 Click  or **Start**.
- 2 Click **All Programs** or **Programs**, and then select the printer program folder from the list.

3 Navigate to:

Printer Home > select your printer > **Settings** tab > **Wireless setup utility**

Note: You may be prompted to connect the printer to the computer again using the installation cable as part of the setup process.

4 Follow the instructions on the computer screen.

For Macintosh users

1 From the Finder, navigate to:

Applications > select your printer folder

2 Double-click **Wireless Setup Assistant**.

3 Follow the instructions on the computer screen.

Wireless print server not installed

You may see a message during installation indicating that the printer does not have a wireless print server installed. If you are sure the printer is capable of wireless printing, try the following:

CHECK POWER

Make sure the  light is on.

“Communication not available” message appears when printing wirelessly

Try one or more of the following:

MAKE SURE YOUR COMPUTER AND PRINTER HAVE VALID IP ADDRESSES FOR THE NETWORK

If you are using a laptop and have power-saving settings enabled, then you may see the “Communication not available” message on your computer screen when you attempt to print wirelessly. This can occur if the laptop hard drive has powered down.

If you see this message, then wait a few seconds and then try to print again. The laptop and printer require a few seconds to power up again and reconnect to the wireless network.

If you see this message again after you have waited long enough for the printer and the laptop to connect to the network, then there may be a problem with your wireless network.

Make sure the laptop and printer have both received IP addresses:

For Windows users

1 Click , or click **Start** and then click **Run**.

2 In the Start Search or Run box, type `cmd`.

3 Press **Enter**, or click **OK**.

4 Type `ipconfig`, and then press **Enter**.

The IP address appears as four sets of numbers separated by periods, such as 192.168.0.100.

For Macintosh users

1 From the Apple menu, navigate to:

About This Mac > More Info

2 From the Contents pane, choose **Network**.

3 If you are connected over a wireless network, choose **AirPort** from the Active Services list.

The Router entry is typically the access point.

Locating the printer IP address

- From the printer, print a network setup page.

In the TCP/IP area, look for **Address**.

- View the printer settings.

1 From the printer control panel, navigate to:

 > **Network Setup > TCP/IP**

2 Look for **IP Address**.

If the printer and/or the laptop does not have an IP address, or if either has an address of 169.254.x.y (where x and y are any two numbers between 0 and 255):

1 Turn off the device that does not have a valid IP address (the laptop, the printer, or both).

2 Turn on the device(s), and then check the IP addresses again.

If the laptop and/or printer still does not receive a valid IP address, then there is a problem with your wireless network. Try the following:

- Make sure your access point (wireless router) is turned on and is working.
- Remove any objects that could be blocking the signal.
- Temporarily turn off any unnecessary wireless devices on your network and pause any network-intensive activities, like large file transfers or network games. If the network is too busy, then it is possible that the printer is not receiving the IP address within the allowed time.
- Make sure your DHCP server, which may also be your wireless router, is working and is configured to assign IP addresses. If you are not sure how to do this, then see the documentation that came with your wireless router.

If the printer and computer have valid IP addresses and the network is operating correctly, then continue troubleshooting.

MAKE SURE THE WIRELESS PORT IS SELECTED

Note: This solution applies to Windows users only.

1 Click , or click **Start** and then click **Run**.

2 In the Start Search or Run box, type `control printers`.

3 Press **Enter**, or click **OK**.

- 4 Right-click the printer, and then select **Properties** or **Printer properties** from the menu.
- 5 Click the **Ports** tab.
- 6 Locate the selected port. The selected port has a check beside it in the Port area.
- 7 If the Description area of the selected port indicates that it is a USB port, then scroll through the list and select the port with Printer Port in the Description area. Check the printer model in the Printer area to make sure you select the right printer port.
- 8 Click **OK**, and then try to print again.

MAKE SURE BIDIRECTIONAL COMMUNICATION IS ENABLED

Note: This solution applies to Windows users only.

- 1 Click , or click **Start** and then click **Run**.
- 2 In the Start Search or Run box, type `control printers`.
- 3 Press **Enter**, or click **OK**.
- 4 Right-click the printer, and then select **Properties** or **Printer properties** from the menu.
- 5 Click the **Ports** tab.
- 6 Click the box next to **Enable bidirectional support** if it is not already checked.
- 7 Click **Apply** > **OK**, and then try to print again.

Communication with printer lost when connected to Virtual Private Network (VPN)

You will lose your connection to a wireless printer on your local network when connected to most *Virtual Private Networks* (VPNs). Most VPNs allow users to communicate with only the VPN and no other network at the same time. If you would like to have the ability to connect to your local network and to a VPN at the same time, then request the system support person for the VPN to allow split tunneling. Be aware that some organizations will not allow split tunneling due to security or technical concerns.

Resolving intermittent wireless communications issues

You may notice that your printer works for a short time and then stops working, although apparently nothing has changed on your wireless network.

Many different issues can interrupt network communications, and sometimes more than one problem exists at the same time. Try one or more of the following:

DISCONNECT FROM ALL VPNs WHEN ATTEMPTING TO USE THE WIRELESS NETWORK

Most Virtual Private Networks (VPNs) allow computers to communicate with only the VPN and no other network at the same time. Disconnect from the VPN before installing the driver on the computer or before running the wireless setup on the computer.

To check if the computer is currently connected to a VPN, open your VPN Client software and check your VPN connections. If you do not have a VPN Client software installed, then check the connections manually using the Windows VPN Client.

If you would like to have the ability to connect to your local network and to a VPN at the same time, then request the system support person for the VPN to allow split tunneling. Be aware that some organizations will not allow split tunneling due to security or technical concerns.

TURN OFF THE ACCESS POINT (WIRELESS ROUTER) AND TURN IT BACK ON

Wait one minute for the printer and computer to reestablish the connection. This can sometimes refresh network connections and resolve connectivity issues.

ELIMINATE NETWORK CONGESTION

If a wireless network is too busy, then the computer and printer may have difficulty communicating with each other. Some causes of wireless network congestion can include:

- Transferring large files across the network
- Networked games
- Peer-to-peer file swapping applications
- Streaming video
- Too many computers on the wireless network at once

ELIMINATE SOURCES OF INTERFERENCE

Common household items can potentially disrupt wireless network communications. Cordless phones (but not cellular phones), microwave ovens, baby monitors, almost any kitchen appliance, wireless surveillance equipment, nearby wireless networks, and any appliance containing a motor can disrupt wireless network communications.

Try turning on any potential sources of interference and see if it causes the problem. If it does, then separate your wireless network from the device.

CHANGE THE CHANNEL THE ACCESS POINT USES

You can sometimes eliminate interference from unknown sources by changing the channel your access point uses to broadcast. There are three distinct channels on a router. See the documentation that came with your router to determine which three apply. Other channels are offered as options, but these overlap. If the router is configured to use the default settings, then change the channel setting to use a different distinct channel. If you are not sure how to change the channel, then see the documentation that came with your access point.

CONFIGURE THE ACCESS POINT WITH A UNIQUE SSID

Many wireless networks use the SSID that the router was originally configured by the manufacturer to use. Using the default SSID can cause problems when more than one network is operating in the same area with the same SSID. The printer or computer may attempt to attach to the wrong network, although it will appear to be trying to connect to the correct network.

To avoid this type of interference, change the SSID on your access point from the default. If you are not sure how to change the SSID, then see the documentation that came with your access point.

Note: You must change the SSID on all of the other devices that access your wireless network if you change the SSID on the access point.

ASSIGN STATIC IP ADDRESSES TO ALL DEVICES IN THE NETWORK

Most wireless networks use a DHCP server (Dynamic Host Configuration Protocol) built in to the wireless router to assign IP addresses to clients on the wireless network. DHCP addresses are assigned when they are needed, as when a new device is added to the wireless network or when it is powered on. Wireless devices must send a request to the router, and receive an IP address in response so they can function on the network. Because the wireless router performs many other tasks besides assigning addresses, it sometimes does not respond quickly enough with an address. The requesting device sometimes gives up before it receives an address.

Try assigning static IP addresses to the devices in your network to resolve this issue.

To assign a static IP address to the printer:

- 1 Complete the wireless setup, allowing the printer to receive a DHCP address from a DHCP server on the network.
- 2 Print a network setup page to see what IP address is currently assigned to the printer.
- 3 Open a Web browser and then type the printer IP address in the address field. Press **Enter**.
- 4 Click **Configuration > TCP/IP > Set static IP address**.
- 5 In the Address field, type the IP address you want to assign to the printer, and then click **Submit**.

Confirm that the IP address is updated by typing the static IP address in the browser address field and checking to see if the printer Web page reloads. For more information on assigning static IP addresses, see the documentation that came with your router and operating system.

CHECK FOR KNOWN ISSUES WITH THE ACCESS POINT

Some wireless routers have documented defects that were identified and resolved by the manufacturers. Visit the company Web site of the router manufacturer. Check for firmware updates and other advice from the manufacturer. See the documentation that came with your wireless router if you are not sure how to reach the manufacturer Web site.

CHECK FOR WIRELESS NETWORK ADAPTER UPDATES

If you are having trouble printing from one particular computer, then check the Web site of the manufacturer of the wireless network adapter card in that computer. It is possible that there is an updated driver available that could resolve the issue.

CHANGE ALL NETWORK DEVICES TO THE SAME TYPE

While it is possible to successfully mix 802.11b, 802.11g, and 802.11n devices on the same wireless network, the faster devices will sometimes prevent the slower devices from communicating.

Try turning on only the network devices of the same type and see if network communications improve. If this solves the problem, then you may want to upgrade your older devices with newer wireless network adapters.

PURCHASE A NEW ROUTER

If your router is several years old, then it may not be fully compatible with the newer wireless devices on your network. Consider purchasing a newer router that is fully compliant with the 802.11 IEEE specifications.

Notices

Product information

Product name:

Dell P513w

Machine type:

4443

Model(s):

7dw, 3dw

Edition notice

August 2010

This publication could include technical inaccuracies or typographical errors. Changes are periodically made to the information herein; these changes will be incorporated in later editions. Improvements or changes in the products or the programs described may be made at any time.

UNITED STATES GOVERNMENT RIGHTS

This software and any accompanying documentation provided under this agreement are commercial computer software and documentation developed exclusively at private expense.

Licensing notices

The following documents can be viewed from the installation software CD.

Directory	File
CD:\LEGAL	FW_License.pdf mDNS.tar.gz Expat.txt Inst_lib.txt Instgui.txt Instgui.zip

Federal Communications Commission (FCC) compliance information statement

This product has been tested and found to comply with the limits for a Class B digital device, pursuant to Part 15 of the FCC Rules. Operation is subject to the following two conditions: (1) this device may not cause harmful interference, and (2) this device must accept any interference received, including interference that may cause undesired operation.

The FCC Class B limits are designed to provide reasonable protection against harmful interference when the equipment is operated in a residential installation. This equipment generates, uses, and can radiate radio frequency energy and, if not installed and used in accordance with the instructions, may cause harmful interference to radio communications. However, there is no guarantee that interference will not occur in a particular installation. If this equipment does cause harmful interference to radio or television reception, which can be determined by turning the equipment off and on, the user is encouraged to try to correct the interference by one or more of the following measures:

- Reorient or relocate the receiving antenna.
- Increase the separation between the equipment and receiver.
- Connect the equipment into an outlet on a circuit different from that to which the receiver is connected.
- Consult your point of purchase or service representative for additional suggestions.

The manufacturer is not responsible for radio or television interference caused by using other than recommended cables or by unauthorized changes or modifications to this equipment. Unauthorized changes or modifications could void the user's authority to operate this equipment.

Note: To assure compliance with FCC regulations on electromagnetic interference for a Class B computing device, use a properly shielded and grounded cable such as Lexmark part number 1021294 for USB attach. Use of a substitute cable not properly shielded and grounded may result in a violation of FCC regulations.

Any questions regarding this compliance information statement should be directed to:

Director of Lexmark Technology & Services
Lexmark International, Inc.
740 West New Circle Road
Lexington, KY 40550
(859) 232-3000

Noise emission levels

The following measurements were made in accordance with ISO 7779 and reported in conformance with ISO 9296.

Note: Some modes may not apply to your product.

1-meter average sound pressure, dBA	
Printing	40 dBA
Scanning	50 dBA
Copying	40 dBA
Ready	inaudible

Temperature information

Ambient temperature	15–32° C (60–90° F)
Shipping temperature	-40–60° C (-40–140° F)
Storage temperature	1–60° C (34–140° F)

Product disposal

Do not dispose of the printer or supplies in the same manner as normal household waste. Consult your local authorities for disposal and recycling options.

Battery notice

This product contains Perchlorate material. Special handling may apply. For more information, go to <http://www.dtsc.ca.gov/hazardouswaste/perchlorate/>.

Power consumption

Product power consumption

The following table documents the power consumption characteristics of the product.

Note: Some modes may not apply to your product.

Mode	Description	Power consumption (Watts)
Printing	The product is generating hard-copy output from electronic inputs.	17.01
Copying	The product is generating hard-copy output from hard-copy original documents.	10.31
Scanning	The product is scanning hard-copy documents.	9.37
Ready	The product is waiting for a print job.	6.95
Power Saver	The product is in energy-saving mode.	3.33
Off	The product is plugged into a wall outlet, but the power switch is turned off.	0.33

The power consumption levels listed in the previous table represent time-averaged measurements. Instantaneous power draws may be substantially higher than the average.

Power Saver

This product is designed with an energy-saving mode called Power Saver. The Power Saver Mode is equivalent to the Sleep Mode. The Power Saver Mode saves energy by lowering power consumption during extended periods of

inactivity. The Power Saver Mode is automatically engaged after this product is not used for a specified period of time, called the Power Saver Timeout.

Factory default Power Saver Timeout for this product (in minutes):
--

10

By using the configuration menus, the Power Saver Timeout can be modified between 1 minute and 240 minutes. Setting the Power Saver Timeout to a low value reduces energy consumption, but may increase the response time of the product. Setting the Power Saver Timeout to a high value maintains a fast response, but uses more energy.

Off mode

If this product has an off mode which still consumes a small amount of power, then to completely stop product power consumption, disconnect the power supply cord from the wall outlet.

Total energy usage

It is sometimes helpful to calculate the total product energy usage. Since power consumption claims are provided in power units of Watts, the power consumption should be multiplied by the time the product spends in each mode in order to calculate energy usage. The total product energy usage is the sum of each mode's energy usage.

European Community (EC) directives conformity

This product is in conformity with the protection requirements of EC Council directives 2004/108/EC, 2006/95/EC and 2005/32/EC on the approximation and harmonization of the laws of the Member States relating to electromagnetic compatibility, safety of electrical equipment designed for use within certain voltage limits and the ecodesign of energy-using products.

The manufacturer of this product is: Lexmark International, Inc., 740 West New Circle Road, Lexington, KY, 40550 USA. The authorized representative is: Lexmark International Technology Hungária Kft., 8 Lechner Ödön fasor, Millennium Tower III, 1095 Budapest HUNGARY, A declaration of conformity to the requirements of the Directives is available upon request from the Authorized Representative.

This product satisfies the Class B limits of EN 55022 and safety requirements of EN 60950.

Industry Canada compliance statement

This Class B digital apparatus meets all requirements of the Canadian Interference-Causing Equipment Standard ICES-003.

Avis de conformité aux normes de l'industrie du Canada

Cet appareil numérique de classe B est conforme aux exigences de la norme canadienne relative aux équipements pouvant causer des interférences NMB-003.

Regulatory notices for telecommunication terminal equipment

This section contains regulatory information pertaining to products that contain telecommunication terminal equipment such as facsimile.

Notice to users of the US telephone network: FCC requirements

This equipment complies with Part 68 of the FCC rules and the requirements adopted by the Administrative Council for Terminal Attachments (ACTA). On the back of this equipment is a label that contains, among other information, a product identifier in the format US:AAAEQ##TXXXX. If requested, this number must be provided to your telephone company.

This equipment uses the RJ-11C Universal Service Order Code (USOC) jack.

A plug and jack used to connect this equipment to the premises' wiring and telephone network must comply with the applicable FCC Part 68 rules and requirements adopted by the ACTA. A compliant telephone cord and modular plug is provided with this product. It is designed to be connected to a compatible modular jack that is also compliant. See your setup documentation for more information.

The Ringer Equivalence Number (REN) is used to determine the number of devices that may be connected to a telephone line. Excessive RENs on a telephone line may result in the devices not ringing in response to an incoming call. In most but not all areas, the sum of RENs should not exceed five (5.0). To be certain of the number of devices that may be connected to a line, as determined by the total RENs, contact your local telephone company. For products approved after July 23, 2001, the REN for this product is part of the product identifier that has the format US:AAAEQ##TXXXX. The digits represented by ## are the REN without a decimal point (for example, 03 is a REN of 0.3). For earlier products, the REN is shown separately on the label.

If this equipment causes harm to the telephone network, the telephone company will notify you in advance that temporary discontinuance of service may be required. If advance notice is not practical, the telephone company will notify the customer as soon as possible. You will also be advised of your right to file a complaint with the FCC.

The telephone company may make changes in its facilities, equipment, operations or procedures that could affect the operation of this equipment. If this happens, the telephone company will provide advance notice in order for you to make necessary modifications to maintain uninterrupted service.

If you experience trouble with this equipment, for repair or warranty information, contact your point of purchase. If the equipment is causing harm to the telephone network, the telephone company may request that you disconnect the equipment until the problem is resolved.

This equipment contains no user serviceable parts. For repair and warranty information, contact your point of purchase.

Connection to party line service is subject to state tariffs. Contact the state public utility commission, public service commission, or corporation commission for information.

If your home has specially wired alarm equipment connected to the telephone line, ensure the installation of this equipment does not disable your alarm equipment. If you have questions about what will disable alarm equipment, consult your telephone company or a qualified installer.

Telephone companies report that electrical surges, typically lightning transients, are very destructive to customer terminal equipment connected to AC power sources. This has been identified as a major nationwide problem. It is recommended that the customer install an appropriate AC surge arrester in the AC outlet to which this device is connected. An appropriate AC surge arrester is defined as one that is suitably rated, and certified by UL (Underwriter's Laboratories), another NRTL (Nationally Recognized Testing Laboratory), or a recognized safety certification body in the country/region of use. This is to avoid damage to the equipment caused by local lightning strikes and other electrical surges.

The Telephone Consumer Protection Act of 1991 makes it unlawful for any person to use a computer or other electronic device, including fax machines, to send any message unless said message clearly contains in a margin at the top or bottom of each transmitted page or on the first page of the transmission, the date and time it is sent and an identification of the business or other entity, or other individual sending the message, and the telephone number

of the sending machine or such business, other entity, or individual. (The telephone number provided may not be a 900 number or any other number for which charges exceed local or long-distance transmission charges.)

See your user documentation in order to program this information into your fax machine.

South Africa telecommunications notice

This modem must be used in conjunction with an approved surge protection device when connected to the PSTN.

Notice to users of the Canadian telephone network

This product meets the applicable Industry Canada technical specifications. The Ringer Equivalence Number (REN) is an indication of the maximum number of terminals allowed to be connected to a telephone interface. The terminus of an interface may consist of any combination of devices, subject only to the requirement that the sum of the RENs of all the devices does not exceed five. The modem REN is located on the rear of the equipment on the product labeling.

Telephone companies report that electrical surges, typically lightning transients, are very destructive to customer terminal equipment connected to AC power sources. This has been identified as a major nationwide problem. It is recommended that the customer install an appropriate AC surge arrestor in the AC outlet to which this device is connected. An appropriate AC surge arrestor is defined as one that is suitably rated, and certified by UL (Underwriter's Laboratories), another NRTL (Nationally Recognized Testing Laboratory), or a recognized safety certification body in the country/region of use. This is to avoid damage to the equipment caused by local lightning strikes and other electrical surges.

This equipment uses CA11A telephone jacks.

Avis réservé aux utilisateurs du réseau téléphonique du Canada

Ce produit est conforme aux spécifications techniques d'Industrie Canada. Le numéro REN (ringer equivalence number : numéro d'équivalence de sonnerie) fournit une indication du nombre maximum de terminaux pouvant être connectés à l'interface téléphonique. En bout de ligne, le nombre d'appareils qui peuvent être connectés n'est pas directement limité, mais la somme des REN de ces appareils ne doit pas dépasser cinq. Le numéro REN du modem est indiqué sur l'étiquette produit située à l'arrière de l'équipement.

Les compagnies de téléphone constatent que les surtensions électriques, en particulier celles dues à la foudre, entraînent d'importants dégâts sur les terminaux privés connectés à des sources d'alimentation CA. Il s'agit-là d'un problème majeur d'échelle nationale. En conséquence, il vous est recommandé de brancher un parasurtenseur dans la prise de courant à laquelle l'équipement est connecté. Utilisez un parasurtenseur répondant à des caractéristiques nominales satisfaisantes et certifié par le laboratoire d'assureurs UL (Underwriter's Laboratories), un autre laboratoire agréé de type NRTL (Nationally Recognized Testing Laboratory) ou un organisme de certification agréé dans votre région ou pays. Ceci prévient tout endommagement de l'équipement causé par les orages et autres surtensions électriques.

Cet équipement utilise des prises de téléphone CA11A.

Notice to users of the New Zealand telephone network

The following are special conditions for the Facsimile User Instructions. The grant of a telepermit for any item of terminal equipment indicates only that Telecom has accepted that the item complies with minimum conditions for connection to its network. It indicates no endorsement of the product by Telecom, nor does it provide any sort of warranty. Above all, it provides no assurance that any item will work correctly in all respects with another item of

telepermitted equipment of a different make or model, nor does it imply that any product is compatible with all of Telecom's network services.

This equipment shall not be set up to make automatic calls to the Telecom's 111 Emergency Service.

This equipment may not provide for the effective hand-over of a call to another device connected to the same line.

This equipment should not be used under any circumstances that may constitute a nuisance to other Telecom customers.

Some parameters required for compliance with Telecom's telepermit requirements are dependent on the equipment associated with this device. The associated equipment shall be set to operate within the following limits for compliance to Telecom's specifications:

- There shall be no more than 10 call attempts to the same number within any 30 minute period for any single manual call initiation, and
- The equipment shall go on-hook for a period of not less than 30 seconds between the end of one attempt and the beginning of the next call attempt.
- The equipment shall be set to ensure that automatic calls to different numbers are spaced such that there is not less than 5 seconds between the end of one call attempt and the beginning of another.

Using this product in Switzerland

This product requires a Swiss billing tone filter to be installed on any line which receives metering pulses in Switzerland. The Lexmark filter must be used, as metering pulses are present on all analog telephone lines in Switzerland.

Utilisation de ce produit en Suisse

Cet appareil nécessite l'utilisation d'un filtre de tonalité de facturation suisse devant être installé sur toute ligne recevant des impulsions de comptage en Suisse. Ce filtre doit être installé car les impulsions de comptage sont utilisées sur toutes les lignes téléphoniques analogiques en Suisse.

Verwendung dieses Produkts in der Schweiz

Für dieses Produkt muss ein Schweizer Billing Tone Filter (zur Zählzeichenübertragung) für jede Leitung installiert werden, über die in der Schweiz Zeitsteuertakte übertragen werden. Die Verwendung des Billing Tone Filters ist obligatorisch, da in allen analogen Telefonleitungen in der Schweiz Zeitsteuertakte vorhanden sind.

Uso del prodotto in Svizzera

Per questo prodotto è necessario un filtro toni Billing svizzero, da installare su tutte le linee che ricevono impulsi remoti in Svizzera. È necessario utilizzare il filtro toni Billing dal momento che gli impulsi remoti sono presenti su tutte le linee telefoniche in Svizzera.

Notice to Users in the European Union

Products bearing the CE mark are in conformity with the protection requirements of EC Council directives 2004/108/EC, 2006/95/EC, and 1999/5/EC on the approximation and harmonization of the laws of the Member States

relating to electromagnetic compatibility, safety of electrical equipment designed for use within certain voltage limits and on radio equipment and telecommunications terminal equipment.

Compliance is indicated by the CE marking.



The manufacturer of this product is: Lexmark International, Inc., 740 West New Circle Road, Lexington, KY, 40550 USA. The authorized representative is: Lexmark International Technology Hungária Kft., 8 Lechner Ödön fasor, Millennium Tower III, 1095 Budapest HUNGARY, A declaration of conformity to the requirements of the Directives is available upon request from the Authorized Representative.

Refer to the table at the end of the Notices section for further compliance information.

Regulatory notices for wireless products

This section contains the following regulatory information pertaining to wireless products that contain transmitters, for example, but not limited to, wireless network cards or proximity card readers.

Exposure to radio frequency radiation

The radiated output power of this device is far below the radio frequency exposure limits of the FCC and other regulatory agencies. A minimum separation of 20 cm (8 inches) must be maintained between the antenna and any persons for this device to satisfy the RF exposure requirements of the FCC and other regulatory agencies.

Notice to users in Brazil

Este equipamento opera em caráter secundário, isto é, não tem direito a proteção contra interferência prejudicial, mesmo de estações do mesmo tipo, e não pode causar interferência a sistemas operando em caráter primário. (Res. ANATEL 282/2001).

Industry Canada (Canada)

This device complies with Industry Canada specification RSS-210. Operation is subject to the following two conditions: (1) this device may not cause interference, and (2) this device must accept any interference, including interference that may cause undesired operation of the device.

This device has been designed to operate only with the antenna provided. Use of any other antenna is strictly prohibited per regulations of Industry Canada.

To prevent radio interference to the licensed service, this device is intended to be operated indoors and away from windows to provide maximum shielding. Equipment (or its transmit antenna) that is installed outdoors is subject to licensing.

The installer of this radio equipment must ensure that the antenna is located or pointed such that it does not emit RF fields in excess of Health Canada limits for the general population; consult Safety Code 6, obtainable from Health Canada's Web site www.hc-sc.gc.ca/rpb.

The term "IC:" before the certification/registration number only signifies that the Industry Canada technical specifications were met.

Industry Canada (Canada)

Cet appareil est conforme à la norme RSS-210 d'Industry Canada. Son fonctionnement est soumis aux deux conditions suivantes :

(1) cet appareil ne doit pas provoquer d'interférences et (2) il doit accepter toute interférence reçue, y compris celles risquant d'altérer son fonctionnement.

Cet appareil a été conçu pour fonctionner uniquement avec l'antenne fournie. L'utilisation de toute autre antenne est strictement interdite par la réglementation d'Industry Canada.

En application des réglementations d'Industry Canada, l'utilisation d'une antenne de gain supérieur est strictement interdite.

Pour empêcher toute interférence radio au service faisant l'objet d'une licence, cet appareil doit être utilisé à l'intérieur et loin des fenêtres afin de garantir une protection optimale.

Si le matériel (ou son antenne d'émission) est installé à l'extérieur, il doit faire l'objet d'une licence.

L'installateur de cet équipement radio doit veiller à ce que l'antenne soit implantée et dirigée de manière à n'émettre aucun champ HF dépassant les limites fixées pour l'ensemble de la population par Santé Canada. Reportez-vous au Code de sécurité 6 que vous pouvez consulter sur le site Web de Santé Canada www.hc-sc.gc.ca/rpb.

Le terme « IC » précédant le numéro de d'accréditation/inscription signifie simplement que le produit est conforme aux spécifications techniques d'Industry Canada.

Taiwan NCC RF notice statement

NCC型式認證設備注意事項 台灣低功率射頻電機設備之使用注意事項

經型式認證合格之低功率射頻電機，非經許可，公司、商號或使用者均不得擅自變更頻率、加大功率或變更原設計之特性及功能。

低功率射頻電機之使用不得影響飛航安全及干擾合法通信；經發現有干擾現象時，應立即停用，並改善至無干擾時方得繼續使用。前項合法通信，指依電信規定作業之無線電信。低功率射頻電機須忍受合法通信或工業、科學及醫療用電波輻射性電機設備之干擾。

Notice to users in the European Union

This product is in conformity with the protection requirements of EC Council directives 2004/108/EC, 2006/95/EC and 2005/32/EC on the approximation and harmonization of the laws of the Member States relating to electromagnetic compatibility, safety of electrical equipment designed for use within certain voltage limits and the ecodesign of energy-using products.

Compliance is indicated by the CE marking.



The manufacturer of this product is: Lexmark International, Inc., 740 West New Circle Road, Lexington, KY, 40550 USA. The authorized representative is: Lexmark International Technology Hungária Kft., 8 Lechner Ödön fasor, Millennium Tower III, 1095 Budapest HUNGARY, A declaration of conformity to the requirements of the Directives is available upon request from the Authorized Representative.

This product satisfies the Class B limits of EN 55022 and safety requirements of EN 60950.

Products equipped with 2.4GHz Wireless LAN option are in conformity with the protection requirements of EC Council directives 2004/108/EC, 2006/95/EC, and 1999/5/EC on the approximation and harmonization of the laws of the Member States relating to electromagnetic compatibility, safety of electrical equipment designed for use within certain voltage limits and on radio equipment and telecommunications terminal equipment.

Compliance is indicated by the CE marking.



Operation is allowed in all EU and EFTA countries, but is restricted to indoor use only.

The manufacturer of this product is: Lexmark International, Inc., 740 West New Circle Road, Lexington, KY, 40550 USA. The authorized representative is: Lexmark International Technology Hungária Kft., 8 Lechner Ödön fasor, Millennium Tower III, 1095 Budapest HUNGARY, A declaration of conformity to the requirements of the Directives is available upon request from the Authorized Representative.

This product may be used in the countries indicated in the table below.

AT	BE	BG	CH	CY	CZ	DE	DK	EE
EL	ES	FI	FR	HR	HU	IE	IS	IT
LI	LT	LU	LV	MT	NL	NO	PL	PT
RO	SE	SI	SK	TR	UK			

Česky	Společnost Lexmark International, Inc. tímto prohlašuje, že výrobek tento výrobek je ve shodě se základními požadavky a dalšími příslušnými ustanoveními směrnice 1999/5/ES.
Dansk	Lexmark International, Inc. erklærer herved, at dette produkt overholder de væsentlige krav og øvrige relevante krav i direktiv 1999/5/EF.
Deutsch	Hiermit erklärt Lexmark International, Inc., dass sich das Gerät dieses Gerät in Übereinstimmung mit den grundlegenden Anforderungen und den übrigen einschlägigen Bestimmungen der Richtlinie 1999/5/EG befindet.
Ελληνική	ΜΕ ΤΗΝ ΠΑΡΟΥΣΑ Η LEXMARK INTERNATIONAL, INC. ΔΗΛΩΝΕΙ ΟΤΙ ΑΥΤΟ ΤΟ ΠΡΟΪΟΝ ΣΥΜΜΟΡΦΩΝΕΤΑΙ ΠΡΟΣ ΤΙΣ ΟΥΣΙΩΔΕΙΣ ΑΠΑΙΤΗΣΕΙΣ ΚΑΙ ΤΙΣ ΛΟΙΠΕΣ ΣΧΕΤΙΚΕΣ ΔΙΑΤΑΞΕΙΣ ΤΗΣ ΟΔΗΓΙΑΣ 1999/5/ΕΚ.
English	Hereby, Lexmark International, Inc., declares that this type of equipment is in compliance with the essential requirements and other relevant provisions of Directive 1999/5/EC.
Español	Por medio de la presente, Lexmark International, Inc. declara que este producto cumple con los requisitos esenciales y cualesquiera otras disposiciones aplicables o exigibles de la Directiva 1999/5/CE.
Eesti	Käesolevaga kinnitab Lexmark International, Inc., et seade see toode vastab direktiivi 1999/5/EÜ põhinõuetele ja nimetatud direktiivist tulenevatele muudele asjakohastele sätetele.
Suomi	Lexmark International, Inc. vakuuttaa täten, että tämä tuote on direktiivin 1999/5/EY oleellisten vaatimusten ja muiden sitä koskevien direktiivin ehtojen mukainen.

Français	Par la présente, Lexmark International, Inc. déclare que l'appareil ce produit est conforme aux exigences fondamentales et autres dispositions pertinentes de la directive 1999/5/CE.
Magyar	Alulírott, Lexmark International, Inc. nyilatkozom, hogy a termék megfelel a vonatkozó alapvető követelményeknek és az 1999/5/EC irányelv egyéb előírásainak.
Íslenska	Hér með lýsir Lexmark International, Inc. yfir því að þessi vara er í samræmi við grunnkröfur og aðrar kröfur, sem gerðar eru í tilskipun 1999/5/EC.
Italiano	Con la presente Lexmark International, Inc. dichiara che questo prodotto è conforme ai requisiti essenziali ed alle altre disposizioni pertinenti stabilite dalla direttiva 1999/5/CE.
Latviski	Ar šo Lexmark International, Inc. deklarē, ka šis izstrādājums atbilst Direktīvas 1999/5/EK būtiskajām prasībām un citiem ar to saistītajiem noteikumiem.
Lietuvių	Šiuo Lexmark International, Inc. deklaruoja, kad šis produktas atitinka esminius reikalavimus ir kitas 1999/5/EB direktyvos nuostatas.
Malti	Bil-preżenti, Lexmark International, Inc., jiddikjara li dan il-prodott huwa konformi mal-ħtiġijiet essenzjali u ma dispożizzjonijiet oħrajn relevanti li jinsabu fid-Direttiva 1999/5/KE.
Nederlands	Hierbij verklaart Lexmark International, Inc. dat het toestel dit product in overeenstemming is met de essentiële eisen en de andere relevante bepalingen van richtlijn 1999/5/EG.
Norsk	Lexmark International, Inc. erklærer herved at dette produktet er i samsvar med de grunnleggende krav og øvrige relevante krav i direktiv 1999/5/EF.
Polski	Niniejszym Lexmark International, Inc. oświadcza, że niniejszy produkt jest zgodny z zasadniczymi wymogami oraz pozostałymi stosownymi postanowieniami Dyrektywy 1999/5/EC.
Português	A Lexmark International Inc. declara que este produto está conforme com os requisitos essenciais e outras disposições da Diretiva 1999/5/CE.
Slovensky	Lexmark International, Inc. týmto vyhlasuje, že tento produkt spĺňa základné požiadavky a všetky príslušné ustanovenia smernice 1999/5/ES.
Slovensko	Lexmark International, Inc. izjavlja, da je ta izdelek v skladu z bistvenimi zahtevami in ostalimi relevantnimi določili direktive 1999/5/ES.
Svenska	Härmed intygar Lexmark International, Inc. att denna produkt står i överensstämmelse med de väsentliga egenskapskrav och övriga relevanta bestämmelser som framgår av direktiv 1999/5/EG.

Index

A

- ad hoc
 - SSID 65
 - WEP 65
- ad hoc network 76
- ad hoc wireless network
 - adding a printer 68
 - creating using Macintosh 65
 - creating using Windows 65
- AliceBox 63
- aligning the printhead 83
- appliances
 - wireless network 77
- application list
 - downloading 59
 - updating 59
- assigning IP address 82

B

- banner paper 26
- bidirectional communication
 - enabling 114
- black and white scanning 59
- buttons
 - printer control panel 14

C

- cable
 - installation 75
 - USB 75
- camera
 - connecting 40
- canceling
 - copy job 53
 - print job 48
 - scan job 59
- cannot delete documents from print queue 92
- cannot print from a flash drive 100
- cannot print through USB 92
- cannot scan to computer over a network 99
- changing Power Saver timeout 17
- changing printing mode 46
- changing temporary settings into default 16

- changing wireless settings after installation (Mac) 64
- changing wireless settings after installation (Windows) 64
- checking
 - ink levels 83
- checking an unresponsive printer 86
- checklist
 - before you troubleshoot 86
 - memory card
 - troubleshooting 100
- cleaning exterior of the printer 85
- cleaning printhead nozzles 84
- Club Internet 63
- collating copies 51
- Communication not available message 114
- computer slows down when printing 97
- configuring
 - IP address 64
- connection
 - configurations 80
- conserving energy
 - using Eco-Mode 17
- conserving energy, ink, and paper 6
- conserving paper
 - using Eco-Mode 17
- continue button greyed out 106
- continue button not working 106
- continue button unavailable 106
- copier or scanner does not respond 98
- copies
 - making 49
- copy and scan troubleshooting
 - cannot scan to computer over a network 99
- copier or scanner does not respond 98
- partial document or photo scans 98
- poor scanned image quality 98
- scan not successful 99
- scanning takes too long or freezes the computer 99

- copy job
 - canceling 53
- copy quality, adjusting 51
- copy troubleshooting
 - scanner unit does not close 98
- copying 49
 - adjusting quality 51
 - collating copies 51
 - enlarging an image 50
 - making a copy lighter or darker 51
 - multiple page images on one sheet 52
 - on both sides of the paper 52, 53
 - Pages per Sheet 52
 - photos 49
 - reducing an image 50
 - repeating an image 52
 - tips 49
 - two-sided document 50
- custom-size paper
 - printing on 35

D

- default printer, setting 45
- defaults
 - resetting factory defaults 17
- disabling settings timeout 16
- documents
 - loading on scanner glass 29
 - printing 30
 - scanning for editing 56
 - scanning using the printer control panel 54
- duplex
 - copying, automatic 52
 - copying, manual 53
 - extending drying time 42
 - printing, automatic 42
 - printing, manual 44
- duplex printing dry time
 - choosing a given setting 44
- duplex unit
 - location 9

E

- Eco-Mode
 - using 17

- editing
 - photos using printer control panel 38
- emission
- notices 120, 122, 126, 127
- energy
 - conserving 6
- enlarging an image 50
- envelopes 27
 - loading 34
 - printing 34
- error using memory card 100
- Ethernet 80
- extending the duplex printing dry time 44
- exterior of the printer
 - cleaning 85
- e-mailing
 - scanned documents 57

F

- factory default settings
 - resetting internal wireless print server 102
 - resetting to 17
- FCC notices 120, 123, 126
- file types
 - supported 37
- finding
 - information 7
 - MAC address 80
 - publications 7
 - Web site 7
- firewall on computer 107
- flash drive
 - inserting 36
 - printing documents from 33
 - printing photos using the proof sheet 41
 - scanning to 55
- France
 - special wireless setup instructions 63
- FreeBox 63

G

- greeting cards 27

H

- heavyweight matte paper 26

I

- improving scan quality 59
- incorrect language appears on display 87
- index cards 27
- information
 - finding 7
- information needed for setting up printer on wireless network 61
- infrastructure network 76
- ink
 - conserving 6
- ink cartridges
 - ordering 11
 - replacing 11
- ink levels
 - checking 83
- inserting a memory card or flash drive 36
- installation
 - cable 75
- installing
 - network printer 82
- installing optional software 22
- interference
 - wireless network 77
- internal wireless print server
 - resetting to factory default settings 102
- IP address 81
 - configuring 64
- IP address, assigning 82
- iron-on transfers 28

J

- jams and misfeeds troubleshooting
 - paper jam in the duplex unit 94
 - paper jam in the paper support 93
 - paper jam in the printer 93
 - paper or specialty media 95

K

- key index 82

L

- labels 27
 - printing 34
- language
 - changing 87

- LiveBox 63
- loading
 - documents on scanner glass 29
 - envelopes 34
- loading paper 25
- locating
 - SSID 72
 - WEP key 71
 - WPA passphrase 71

M

- MAC address 80
 - finding 80
- MAC address filtering 80
- Macintosh printer software
 - using 21
- memory card
 - inserting 36
 - printing documents from 33
 - printing photos using the proof sheet 41
 - scanning to 55
 - supported types 37
- memory card cannot be inserted 100
- memory card slot
 - location 9
- memory card troubleshooting
 - cannot print from a flash drive 100
 - checklist 100
 - nothing happens when memory card is inserted 100
- minimum system requirements 19
- multiple WEP keys 82

N

- N9UF Box 63
- network connection
 - with USB 80
- network overview 72
- network printer
 - installing 82
- network security 72
- network setup page
 - printing 61
- networking
 - finding IP address of computer 81
 - finding IP address of printer 81
 - IP addresses 81

- sharing the printer with a Macintosh computer 71
- sharing the printer with a Windows computer 71
- no wireless network 65
- noise emission levels 120
- nothing happens when memory card is inserted 100
- notices 120, 121, 122, 123, 124, 125, 126, 127, 128

P

- page does not print 90
- Pages per Sheet copies 52
- paper
 - conserving 6
- paper and media
 - banner paper 26
 - envelopes 27
 - heavyweight matte paper 26
 - index cards 27
 - iron-on transfers 28
 - photo cards 27
 - photo/glossy paper 27
 - plain paper 26
 - postcards 27
 - transparencies 28
- paper default settings
 - saving 28
- paper exit tray
 - location 9
- paper feed guard
 - location 9
- paper guides
 - location 9
- paper jam in the duplex unit 94
- paper jam in the paper support 93
- paper jam in the printer 93
- paper or specialty media
 - misfeeds 95
- paper support
 - location 9
- partial document or photo scans 98
- parts
 - power supply port 10
- password 72
- pausing
 - print job 47
- PDF
 - creating from scan 58
- photo cards 27

- photo/glossy paper 27
- photos
 - adding frames 38
 - adjusting brightness 38
 - applying color effects 38
 - copying photos 49
 - cropping 38
 - editing using printer control panel 38
 - enhancing automatically 38
 - making borderless copies 50
 - printing from digital camera using DPOF 42
 - printing using printer control panel 37
 - printing using the proof sheet 41
 - reducing red-eye effect 38
 - rotating 38
 - scanning for editing 55
- photos do not print from memory card across wireless network 101
- photos from memory device
 - printing using printer software 39
- PictBridge and USB port
 - location 9
- PictBridge-enabled camera, connecting 40
- plain paper 26
- poor quality at the edges of page 95
- poor scanned image quality 98
- postcards 27
- Power Saver timeout
 - changing 17
- power supply port
 - location 10
- print job
 - canceling 48
 - pausing 47
 - resuming 47
- print media
 - greeting cards 27
 - labels 27
- print speed is slow 97
- print troubleshooting
 - cannot delete documents from print queue 92
 - computer slows down when printing 97
 - poor quality at the edges of page 95

- slow print speed 97
- streaks or lines on printed image 96
- printer
 - sharing 70
 - sharing in Windows 70
- printer control panel
 - buttons 14
 - location 9
 - using 14
- printer does not print
 - wireless 107
- printer does not print wirelessly 108
- printer does not respond 92
- printer printing blank pages 91
- printer problems, basic solutions 86
- printer software
 - uninstalling 23
- printer, setting as default 45
- printhead
 - aligning 83
 - location 10
- printhead error 87
- printhead nozzles
 - cleaning 84
- printing
 - collate 31
 - custom-size paper 35
 - documents 30
 - documents from memory card or flash drive 33
 - envelopes 34
 - from a PictBridge-enabled camera 40
 - labels 34
 - last page first 31
 - multiple pages on one sheet 32
 - network setup page 61
 - on both sides of the paper 42, 44
 - photos from digital camera using DPOF 42
 - photos from memory device using printer software 39
 - photos using printer control panel 37
 - photos using the proof sheet 41
 - reverse page order 31
 - tips 30
 - two-sided 42, 44
- printing in draft mode 46

- printing mode
 - changing 46
- proof sheet
 - using 41
- protocol 81
- publications
 - finding 7

R

- recycling 6
 - Dell products 13
- reducing an image 50
- repeating an image 52
- replacing ink cartridges 11
- resetting
 - internal wireless print server to factory default settings 102
- resetting to factory defaults 17
- resuming
 - print job 47
- reverse page order 31

S

- safety information 5
- saving paper default settings 28
- scan
 - black and white 59
 - improving quality 59
 - PIN 59
- scan job
 - canceling 59
- scan was not successful 99
- scanner glass
 - cleaning 85
 - location 10
- scanner lid
 - location 9
- scanner unit
 - location 10
- scanner unit does not close 98
- scanning
 - creating a PDF from scan 58
 - documents for editing 56
 - documents for e-mailing 57
 - photos for editing 55
 - tips 54
 - to a computer 54
 - to a flash drive 55
 - to a memory card 55
 - to a network 54

- using the printer control panel 54
- scanning takes too long or freezes the computer 99
- security
 - wireless network 60
- security information
 - wireless network 72
- security key 72
- security slot
 - location 9
- selecting the wireless port 114
- Service Center 86
- setting the duplex printing dry time 44
- settings timeout
 - disabling 16
- setup troubleshooting
 - cannot print through USB 92
 - incorrect language appears on display 87
 - page does not print 90
 - printer does not respond 92
 - printer printing blank pages 91
 - printhead error 87
 - software did not install 90
- shared printing 71
- sharing printer in Windows 70
- software
 - Service Center 86
 - software did not install 90
 - software updates
 - checking 23
 - enabling 23
 - software, optional
 - finding, installing 22
- SSID
 - ad hoc 65
 - finding 78
 - locating 72
 - wireless network 72
- streaks or lines on printed image 96
- supported memory cards and file types 37
- supported operating systems 19
- switching from USB
 - to wireless 68
- switching from wireless
 - to USB 68

T

- TCP/IP 81
- technical support 86
- telecommunication notices 123, 124, 125
- temporary settings
 - changing into default 16
- tips for
 - copying 49
 - printing 30
 - scanning 54
- transparencies 28
- troubleshooting
 - checking an unresponsive printer 86
 - contacting technical support 86
 - Service Center 86
 - solving basic printer problems 86
 - wireless network 101
- troubleshooting, copy
 - scanner unit does not close 98
- troubleshooting, copy and scan
 - cannot scan to computer over a network 99
 - copier or scanner does not respond 98
 - partial document or photo scans 98
 - poor scanned image quality 98
 - scan not successful 99
 - scanning takes too long or freezes the computer 99
- troubleshooting, jams and misfeeds
 - paper jam in the duplex unit 94
 - paper jam in the paper support 93
 - paper jam in the printer 93
 - paper or specialty media 95
- troubleshooting, memory card
 - cannot print from a flash drive 100
 - checklist 100
 - nothing happens when memory card is inserted 100
- troubleshooting, print
 - cannot delete documents from print queue 92
 - computer slows down when printing 97

- poor quality at the edges of page 95
- slow print speed 97
- streaks or lines on printed image 96
- troubleshooting, setup
 - cannot print through USB 92
 - incorrect language appears on display 87
 - page does not print 90
 - printer does not respond 92
 - printer printing blank pages 91
 - printhead error 87
 - software did not install 90
- troubleshooting, wireless
 - changing wireless settings after installation (Mac) 64
 - changing wireless settings after installation (Windows) 64
 - photos do not print from memory card across wireless network 101
 - resolving communication problems 116
 - Wi-Fi indicator light is not lit 107
 - Wi-Fi indicator light is still orange 109
 - Wi-Fi indicator light shows limited connection 110
- Two-Sided Printing Dry Time
 - choosing a given setting 44

U

- UK
 - special wireless setup instructions 63
- uninstalling printer software 23
- updating printer software 23
- updating the application list 59
- USB 68, 80
 - cable 75
- USB connection
 - with network connection 80
- USB port
 - location 10
- using
 - Macintosh printer software 21

V

- Virtual Private Network 116

- VPN
 - lost connection to printer 116

W

- Web site
 - finding 7
- WEP 60
 - ad hoc 65
- WEP key
 - key index 82
 - locating 71
- Windows software
 - Abbyy Sprint OCR 19
 - Adobe Photo Album Starter Edition 19
 - Dell Ink Management System 19
 - Fast Pics 19
 - Fax Setup Utility 19
 - Fax Solutions software 19
 - Printer Home 19
 - Printing Preferences 19
 - Service Center 19
 - Toolbar 19
 - Wireless Setup Utility 19
- wireless 68, 80
 - printer does not print 107
 - troubleshooting 108, 116
- wireless network
 - adding a printer to existing ad hoc network 68
 - common home configurations 73
 - creating an ad hoc network using Macintosh 65
 - creating an ad hoc network using Windows 65
 - information needed for setting up wireless printing 61
 - interference 77
 - resolving communication problems 116
 - security 60
 - security information 72
 - signal strength 77
 - SSID 72
 - troubleshooting 101
 - types of wireless networks 76
- wireless network compatibility 60
- wireless print server
 - not installed 114
- wireless settings
 - changing after installation (Mac) 64
 - changing after installation (Windows) 64
- wireless setup
 - information needed for 61
- wireless signal
 - strength 77
- wireless signal absorption 77
- wireless troubleshooting
 - changing wireless settings after installation (Mac) 64
 - changing wireless settings after installation (Windows) 64
 - photos do not print from memory card across wireless network 101
 - printer and computer on different networks 78
 - printer works intermittently on wireless network 116
- Wi-Fi indicator light is not lit 107
- Wi-Fi indicator light is still orange 109
- Wi-Fi indicator light shows limited connection 110
- Wi-Fi indicator
 - description of colors 63
 - light is not lit 107
 - location 9
- Wi-Fi indicator light is green
 - printer does not print 108
- Wi-Fi indicator light is still orange 109
- Wi-Fi indicator light shows limited connection 110
- Wi-Fi Protected Setup 68
 - using 71
- Wi-Fi Protected Setup logo
 - identifying 71
- WPA 60
- WPA passphrase
 - locating 71
- WPA2 60
- WPS 68